

Villa Door Station

User's Manual







Foreword

General

This manual introduces the installation, functions and operations of the villa door station device (hereinafter referred to as "the VTO"). Read carefully before using the device, and keep the manual safe for future reference.

Safety Instructions

The following categorized signal words with defined meaning might appear in the manual.

Signal Words	Meaning
 DANGER	Indicates a high potential hazard which, if not avoided, will result in death or serious injury.
 WARNING	Indicates a medium or low potential hazard which, if not avoided, could result in slight or moderate injury.
 CAUTION	Indicates a potential risk which, if not avoided, could result in property damage, data loss, lower performance, or unpredictable result.
 TIPS	Provides methods to help you solve a problem or save you time.
 NOTE	Provides additional information as the emphasis and supplement to the text.

Revision History

Version	Revision Content	Release Date
V1.0.3	Revised "Important Safeguards and Warnings".	December 2022
V1.0.2	Revised facade layout description.	November 2022
V1.0.1	Revised room number configuration in facade layout module.	June 2022
V1.0.0	First release.	December 2021

Privacy Protection Notice

As the device user or data controller, you might collect the personal data of others such as their face, fingerprints, and license plate number. You need to be in compliance with your local privacy protection laws and regulations to protect the legitimate rights and interests of other people by implementing measures which include but are not limited: Providing clear and visible identification to inform people of the existence of the surveillance area and provide required contact information.

About the Manual

- The manual is for reference only. Slight differences might be found between the manual and the

product.

- We are not liable for losses incurred due to operating the product in ways that are not in compliance with the manual.
- The manual will be updated according to the latest laws and regulations of related jurisdictions. For detailed information, see the paper user's manual, use our CD-ROM, scan the QR code or visit our official website. The manual is for reference only. Slight differences might be found between the electronic version and the paper version.
- All designs and software are subject to change without prior written notice. Product updates might result in some differences appearing between the actual product and the manual. Please contact customer service for the latest program and supplementary documentation.
- There might be errors in the print or deviations in the description of the functions, operations and technical data. If there is any doubt or dispute, we reserve the right of final explanation.
- Upgrade the reader software or try other mainstream reader software if the manual (in PDF format) cannot be opened.
- All trademarks, registered trademarks and company names in the manual are properties of their respective owners.
- Please visit our website, contact the supplier or customer service if any problems occur while using the device.
- If there is any uncertainty or controversy, we reserve the right of final explanation.

Important Safeguards and Warnings

This section introduces content covering the proper handling of the device, hazard prevention, and prevention of property damage. Read carefully before using the device, and comply with the guidelines when using it.

Operation Requirements



- Check whether the power supply is correct before use.
- Do not unplug the power cord on the side of the device while the adapter is powered on.
- Operate the device within the rated range of power input and output.
- Transport, use and store the device under allowed humidity and temperature conditions.
- If the device is powered off for longer than a month, it should be placed in its original package and sealed. Make sure to keep it away from moisture, and store it under allowed humidity and temperature conditions.
- Do not drop or splash liquid onto the device, and make sure that there is no object filled with liquid on the device to prevent liquid from flowing into it.
- Do not disassemble the device without professional instruction.

Installation Requirements



WARNING

- Do not connect the power adapter to the device while the adapter is powered on.
- Strictly comply with the local electric safety code and standards. Make sure the ambient voltage is stable and meets the power supply requirements of the device.
- Do not connect the device to two or more kinds of power supplies, to avoid damage to the device.
- Improper use of the battery might result in a fire or explosion.



WARNING

- Personnel working at heights must take all necessary measures to ensure personal safety including wearing a helmet and safety belts.
- Do not place the device in a place exposed to sunlight or near heat sources.
- Keep the device away from dampness, dust, and soot.
- Install the device on a stable surface to prevent it from falling.
- Install the device in a well-ventilated place, and do not block its ventilation.
- Use an adapter or cabinet power supply provided by the manufacturer.
- Use the power cords that are recommended for the region and conform to the rated power specifications.
- The power supply must conform to the requirements of ES1 in IEC 62368-1 standard and be no higher than PS2. Please note that the power supply requirements are subject to the device label.
- The device is a class I electrical appliance. Make sure that the power supply of the device is connected to a power socket with protective earthing.

Table of Contents

Foreword	I
Important Safeguards and Warnings	III
1 Initializing the VTO	1
1.2 Web.....	1
1.3 DMSS APP	3
2 Login and Resetting Password	7
2.1 Login	7
2.2 Resetting Password	7
3 Home Page	9
4 Local Settings	10
4.1 Basic Settings.....	10
4.1.1 Device Properties & Events.....	10
4.1.2 Facade Layout	11
4.2 Video & Audio	13
4.3 Access Control Settings	16
4.3.1 Local.....	16
4.3.2 RS-485	17
4.4 System	17
4.5 Security	19
4.6 Onvif User.....	21
4.7 Update.....	22
4.8 Upload File.....	22
4.9 Legal Info.....	23
5 Household Setting	24
5.1 VTO No. Management	24
5.2 VTH Management.....	25
5.3 Personnel Management	26
5.4 VTS Management.....	29
5.5 Status	30
6 Network	31
6.1 Basic	31
6.1.1 TCP/IP	31
6.1.2 Port.....	32
6.1.3 Cloud service	33
6.2 UPnP.....	33
6.2.2 Enabling UPnP Services.....	33
6.2.3 Adding UPnP Services.....	34
6.3 SIP Server	34
6.4 Wi-Fi.....	36
6.5 Firewall	37
7 Log Management	38
7.1 Call	38
7.2 Alarm	38
7.3 Unlock	39

7.4 Log	39
8 Button Model Configuration	40
8.1 Cable Connection	40
8.2 VTH Configuration	40
Appendix 1 Cybersecurity Recommendations	42

1 Initializing the VTO

You can initialize the VTO on the web or through DMSS app, depending on which network connection your model support.

Table 1-1 Initialization type

Network Connection	Initialization Through Web	Initialization Through DMSS App
Wi-Fi connection	No	Yes
Wired connection	Yes	Yes

1.2 Web

For first-time login, you need to initialize the VTO.

Step 1 Power on the VTO.

Step 2 Go to the default IP address (192.168.1.108) of the VTO.



Make sure that the IP address of your PC is on the same network segment as the VTO.

Figure 1-2 Device initialization

The screenshot shows a 'Device Init' window with a dark theme. At the top, there are three numbered steps: '1 One', '2 Two', and '3 Three'. Below this, the 'Username' field is pre-filled with 'admin'. The 'Password' field is empty, with three buttons labeled 'Low', 'Middle', and 'High' below it. The 'Confirm Password' field is also empty. At the bottom, there is a 'Next' button.

Step 3 On the **Device Init** page, enter and confirm the password, and then click **Next**.



The password must consist of 8–32 non-blank characters and contain at least two types of the following characters: Uppercase, lowercase, numbers, and special characters (excluding ' " ; : &).

Figure 1-3 Set an email address

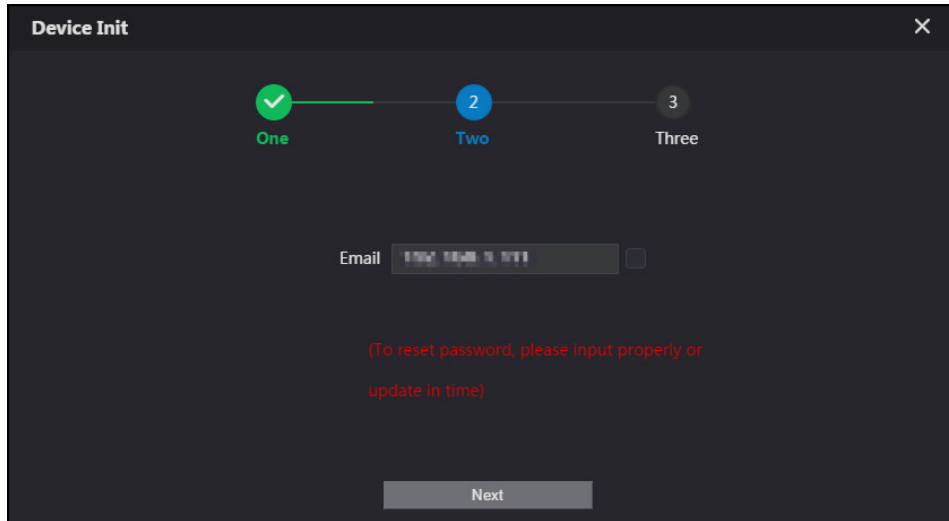

Step 4 Select the **Email** checkbox and enter an email address for resetting password.

Step 5 Click **Next**.

Figure 1-4 Initialization successful

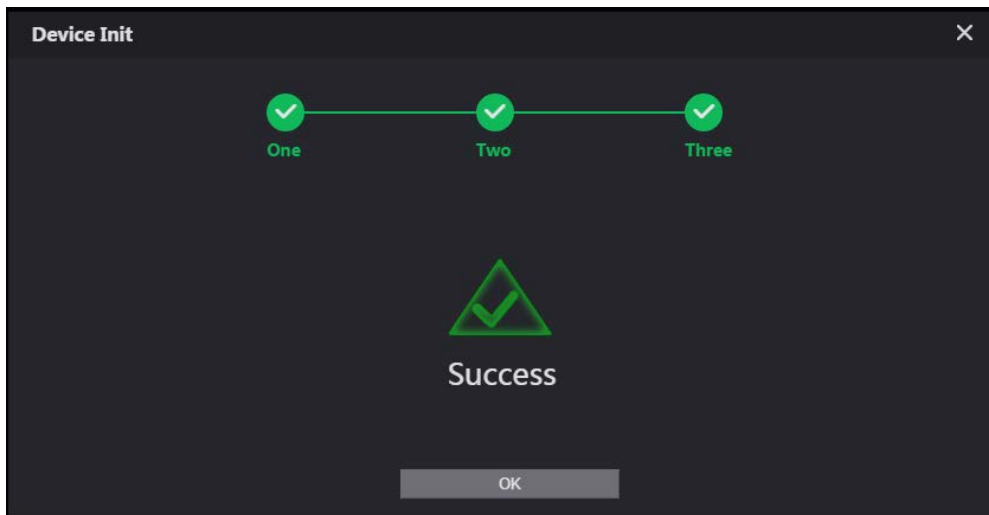

Step 6 Click **OK** to go to the login page.

Step 7 Enter the username (admin by default) and password to log in to the web page.

Figure 1-5 Login page

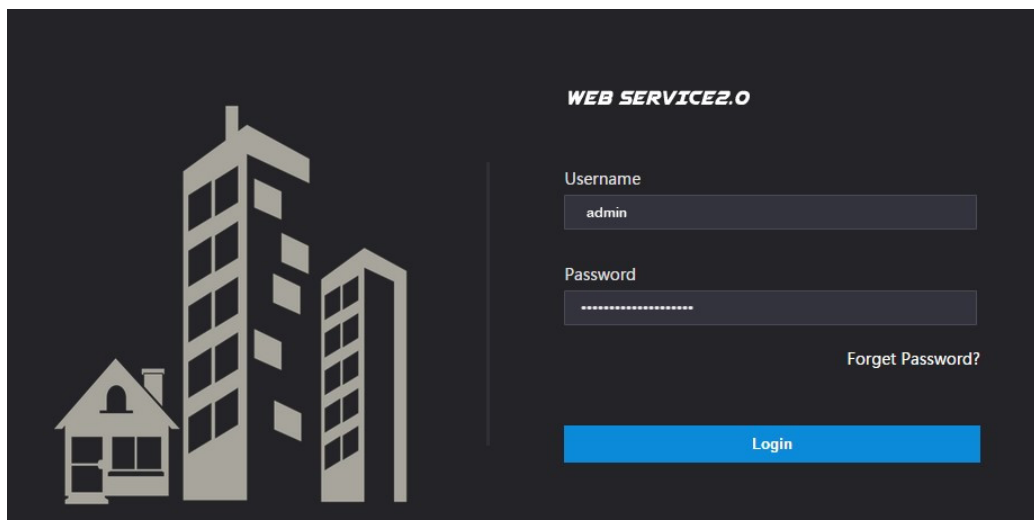

1.3 DMSS APP

If your model only supports Wi-Fi connection to the network, you can only initialize the VTO on the DMSS app. For detailed operation of the app, refer to its User's Manual.

Prerequisites

You have downloaded the DMSS in the APP Store (iOS) or Google Play (Android), and have created an account and logged into the app.

Operations

Step 1 Power on the VTO.

Step 2 Enable hotspot on the VTO through pressing and holding the call button on the VTO until you heard the voice prompt.



The hotspot function is to enable you connect the VTO to the network through **AP configuration** on the app.

Step 3 Add the VTO to the DMSS app.

1) On the **Home** screen, tap **+**, and then select **SN/Scan**.

2) Add a VTO.

You can add through scanning the QR code at the rear panel of the VTO.

3) The SN number of the VTO appears automatically, and then tap **Next**.

4) Select device type as **VTO**, and then the device information appears.

5) Tap **View Reasons**.

Figure 1-6 Add VTO to DMSS

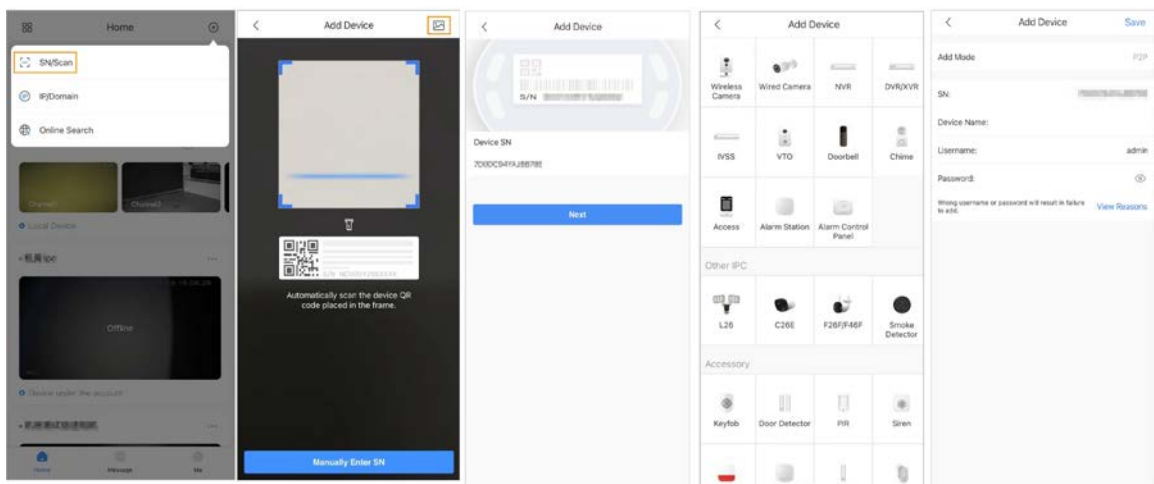

6) Configure network by switch networking to **AP Configuration**, and then tap **Next**.

7) Connect your phone to the hotspot you just enabled on the VTO.



- The hotspot name is the SN number of your VTO.

- The current page will move on to the next step automatically after connection.

Figure 1-7 AP configuration

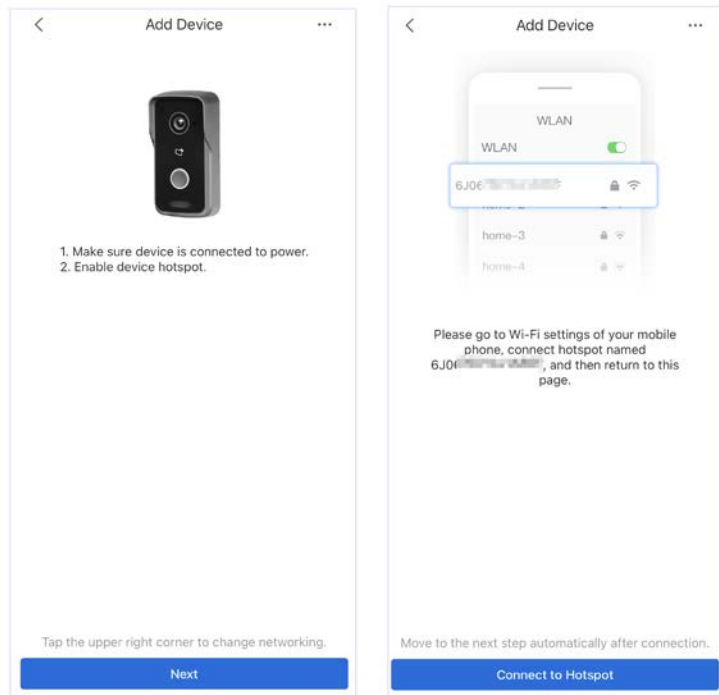

- Step 4** Complete initialization based on instructions on the app.
- 1) Enter the password you planned for the VTO, and confirm it, and then tap **Next**.
 - 2) Select **Cloud Access** and **Auto-check**, and then tap **OK**.
- The initialization process is completed.

Figure 1-8 Initialization

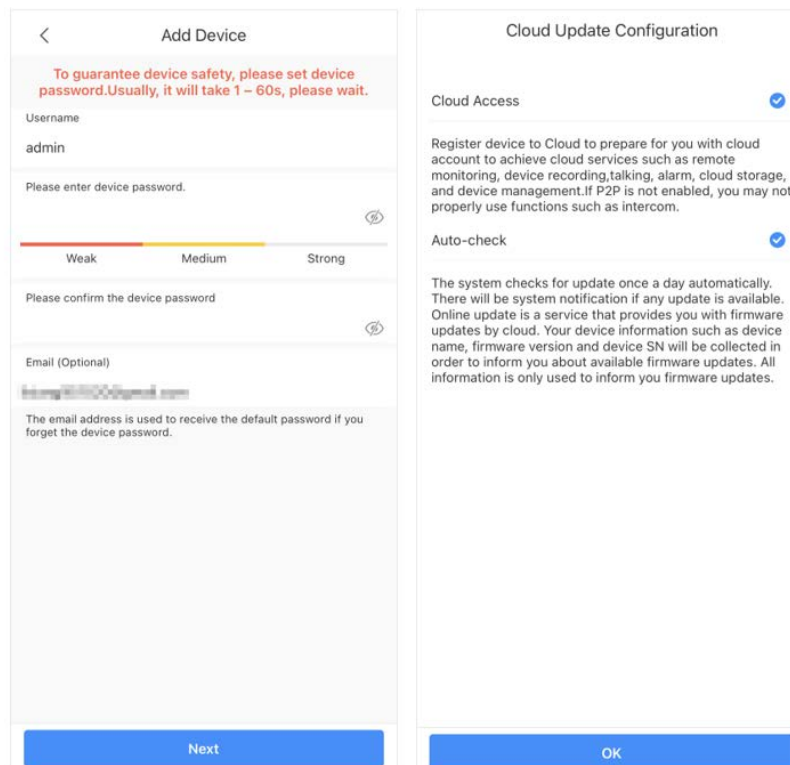

- Step 5** Connect the VTO to the network through Wi-Fi.
- 1) Select an available Wi-Fi.
 - 2) Enter the password and tap **Next**. Wait for the VTO to connect to the router.

Figure 1-9 Wi-Fi connection

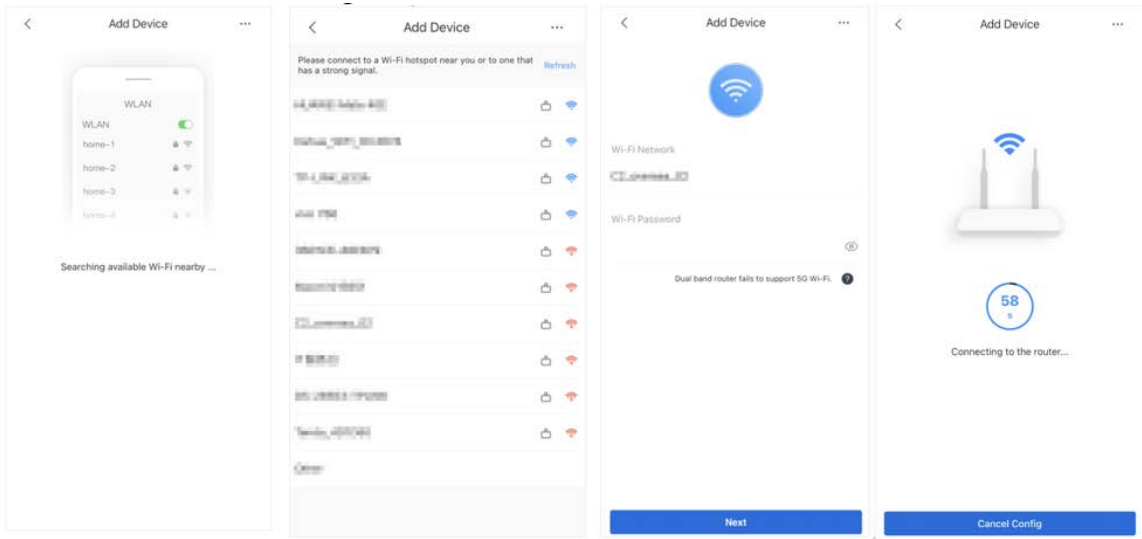

Step 6 Configure device name, and tap **Save**.

Figure 1-10 Configure device name

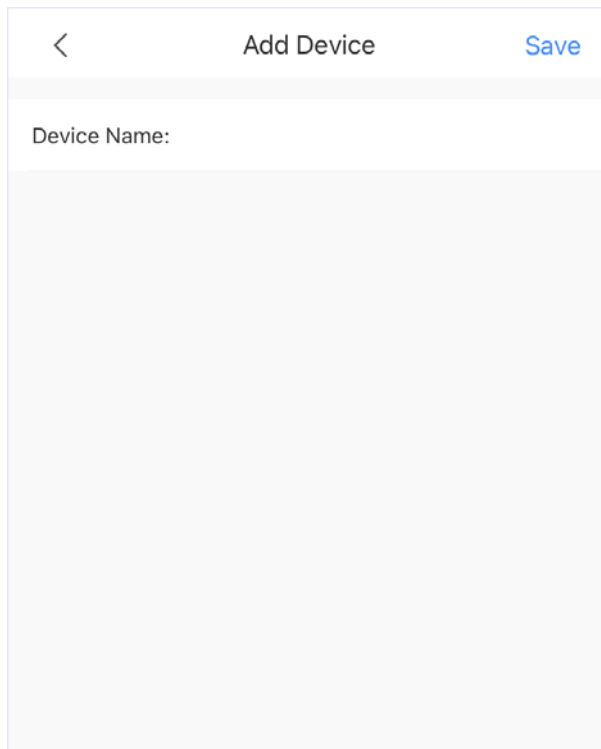

Step 7 View monitoring video from the camera on the VTO.

Figure 1-11 Monitor

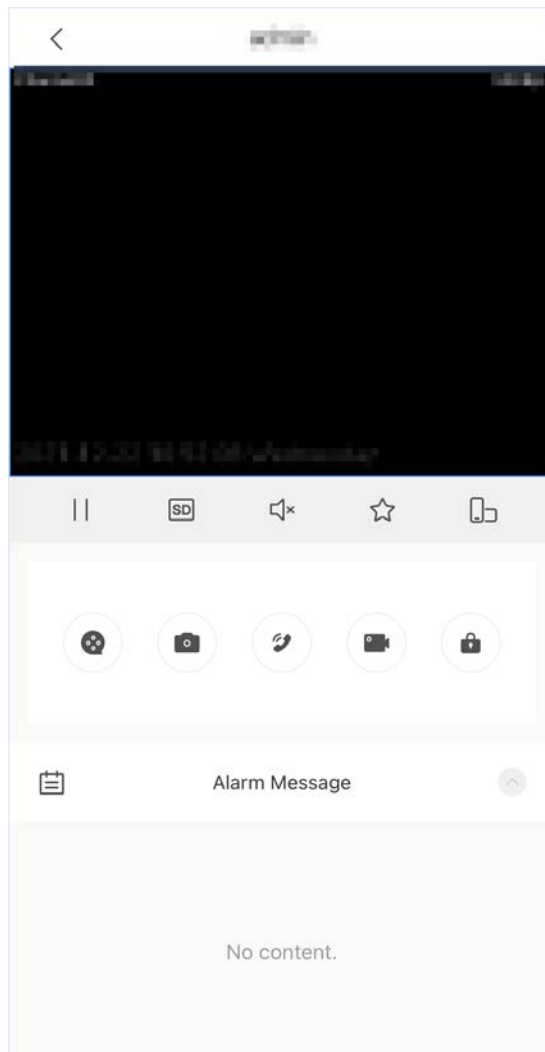

2 Login and Resetting Password

2.1 Login

Before login, make sure that the PC is on the same network segment as the VTO.

Step 1 Go to the IP address of the VTO in the browser.



For first-time login, enter the default IP (192.168.1.108). If you have multiple VTOs, we recommend that you change the default IP address (**Network > Basic**) to avoid conflict.

Step 2 Enter **admin** as the username, and enter the password you set during initialization, and then click **Login**.

Figure 2-1 Login

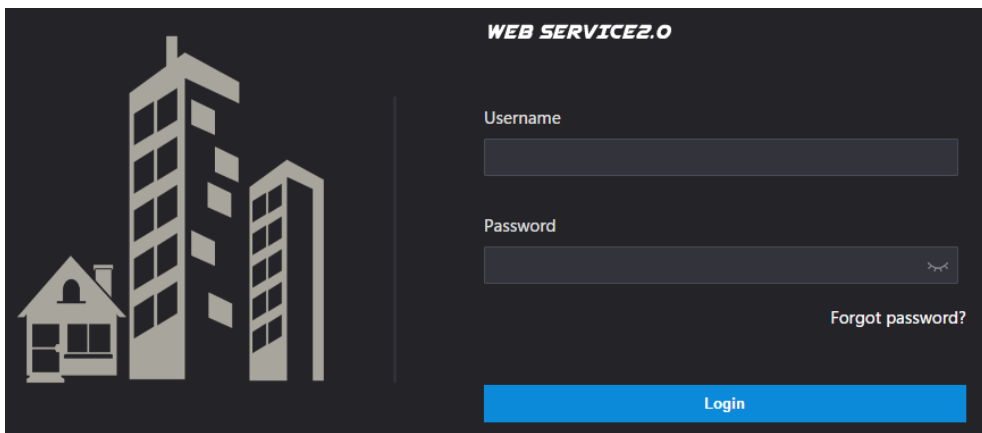

2.2 Resetting Password

Step 1 On the login page, click **Forgot Password?**, and then click **Next**.

Figure 2-2 Reset the password

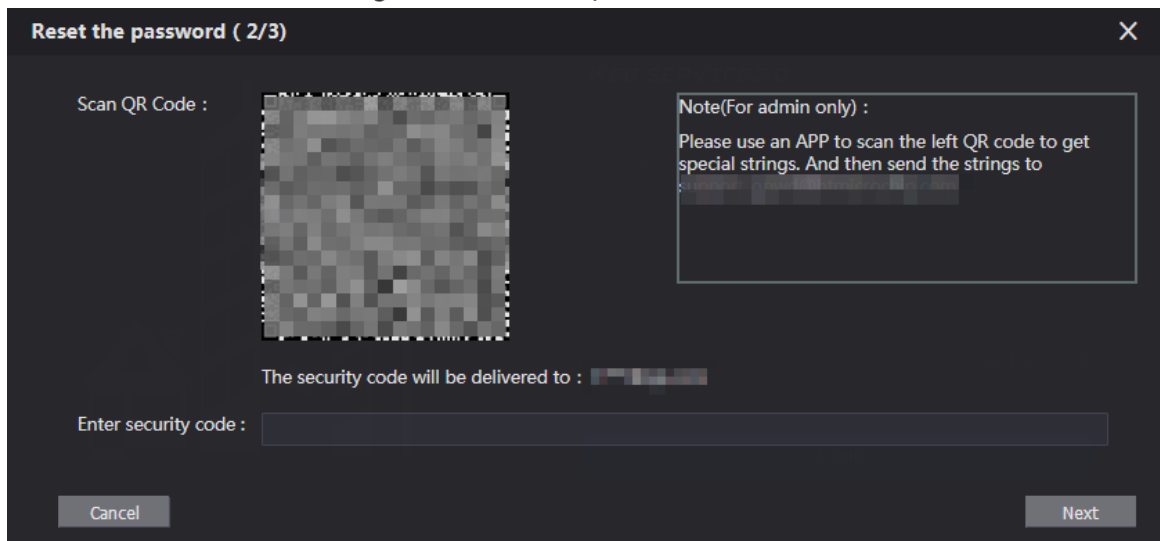

Step 2 Scan the QR code, and then you will get a string of numbers and letters.

Step 3 Send the string to the email account displayed on the page, and then the security code will be sent to the email address configured during initialization.

Step 4 Enter the security code in the input box, and then click **Next**.



- If you did not set an email address during initialization, contact your supplier or customer service for help.
- The security code will be valid only for 24 hours upon receipt.
- If you enter the wrong security code for 5 consecutive times, your account will be locked for 5 minutes.

Step 5 Enter and confirm the new password, and then click **OK**.

3 Home Page

Figure 3-1 Home Page

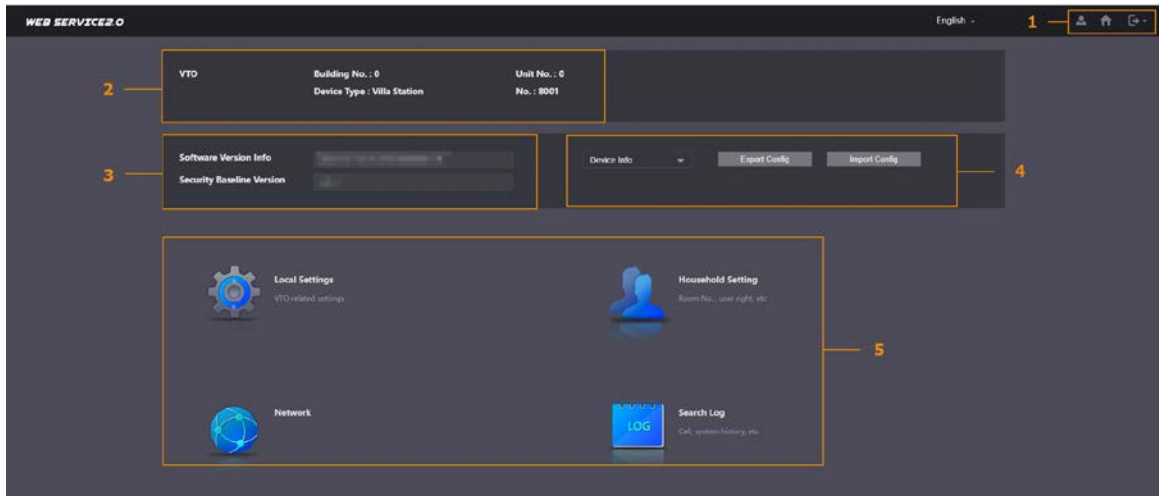

Table 3-1 Home page introduction

No.	Function	Description
1	General function	<ul style="list-style-type: none"> : Change the password and your email address. : Go to the home page. : Log out, restart the VTO or restore the VTO to factory settings. <p></p> <p>If you restore the VTO to factory settings, all data except external storage will be deleted. You can format the SD card to delete the data in it.</p>
2	VTO information	View the information of the VTO and the system.
3	System information	
4	Configuration manager	Export or import VTO configuration or user information.
5	Function	<p>Configure parameters for different functions.</p> <p></p> <p>The web page and the functions might be different depending on the model.</p>

4 Local Settings

This chapter introduces the detailed configuration of the VTO.



Slight differences might be found in different models.

4.1 Basic Settings

4.1.1 Device Properties & Events

Step 1 Select **Local Settings** > **Basic**.

Step 2 Configure the parameters.

Figure 4-1 Basic

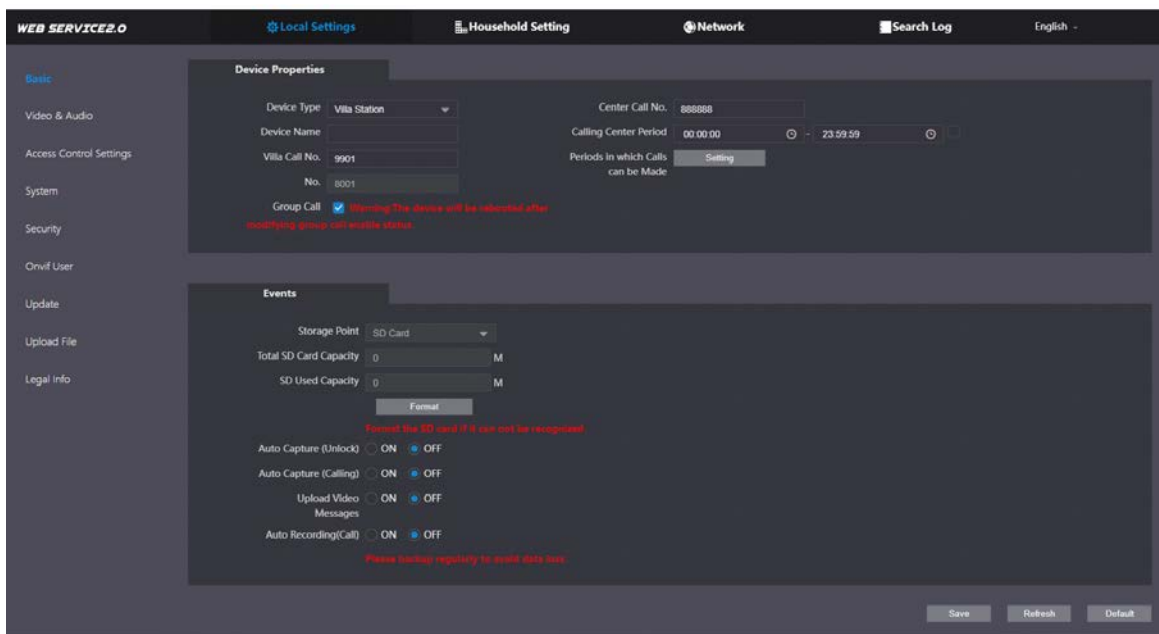



Table 4-1 Basic parameter description

Parameter	Description
Device Type	Select Villa Station or Small Apartment .
Center Call No.	The default phone number for the management center is 888888, and you can set it to any number with up to 9 digits.
Device Name	When other devices are monitoring this VTO, the device name will appear on the monitoring image.
Calling Center Period	Time period in which the management center can be called. Configure the time and enable the function so that you will receive calls only in that period.

Parameter	Description
Villa Call No.	Used to call VTHs.
No.	Used to differentiate each VTO, and we recommend you set it according to unit or building number, and then you can add VTOs to the SIP server by using their numbers.  The number cannot be changed when the VTO serves as the SIP server.
Periods in which Calls can be Made	Configure the time if you only want to receive calls from VTH during a specific period.
Group Call	Enable it on the VTO that works as the SIP server, and when a main VTH receives a call, all extension VTHs will also receive the call.
Storage Point	SD card by default.
Total SD Card Capacity	Displays the total and used capacity of the SD card. You can click Format to delete all the data in the SD card.
SD Used Capacity	
Format	
Auto Capture (Unlock)	When the door is unlocked, the VTO will take two snapshots and save them to the SD card.
Auto Capture (Calling)	Take a snapshot and save it in the SD card of the VTO when the VTO is calling.
Upload Video Messages	When enabled: <ul style="list-style-type: none"> ● If an SD card is inserted in both the VTH and VTO, the video message will be saved both in the SD cards of the VTH and the VTO. ● If an SD card is only inserted in the VTH or the VTO, the video message will be saved only in the SD card of the VTH or the VTO. ● If no SD card is inserted in the VTH or VTO, no video message will be saved.
Auto Recording (Call)	Take recording when the VTO is in a call, and save the recording in the SD card of the VTO.

Step 3 Click **Save**.

4.1.2 Facade Layout

This function is only available for the VTO model with multiple buttons (1 button, 2 buttons and 4 buttons). Here is an example of configuration for the VTO that has one button installed on its device.

Procedures

Step 1 Log in to the web page of the VTO.

Step 2 Select **Local Settings > Basic**.

Step 3 In the **Facade Layout** section, click the nameplates next to where you have installed the button, and then select the room number from the **Room List** you want to bind. For example, 9901.



- The VTH room numbers in the **Room List** are configured in **Household Setting > VTH Management**.

- You need to configure the room number based on your installation of buttons. For example, if you have only installed one button next to the first nameplate, then you need to click the module of first nameplate to configure the room number on the web page. If you have installed one button next to the fourth nameplate, then you need to click the module of fourth nameplate to configure the room number on the web page. Keep the above configuration rule when you install 2 buttons or 4 buttons on the VTO and configure the corresponding room numbers on the web page.

Figure 4-2 Fourth button installation

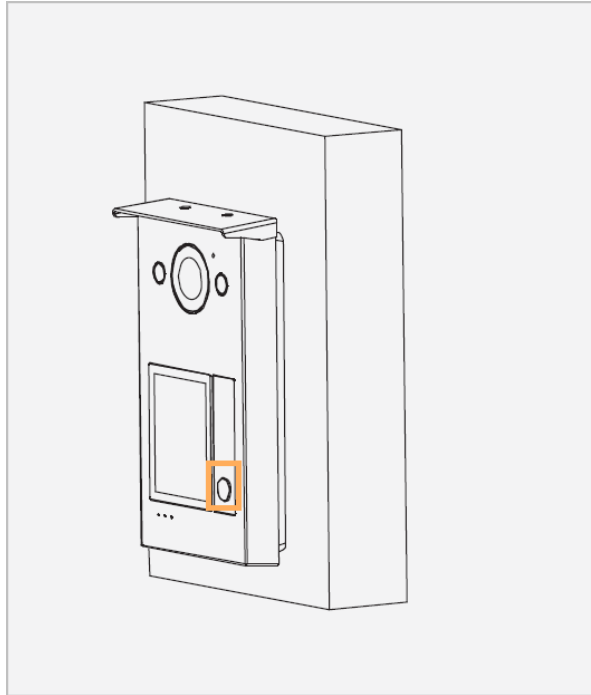

Figure 4-3 Configure the fourth nameplate

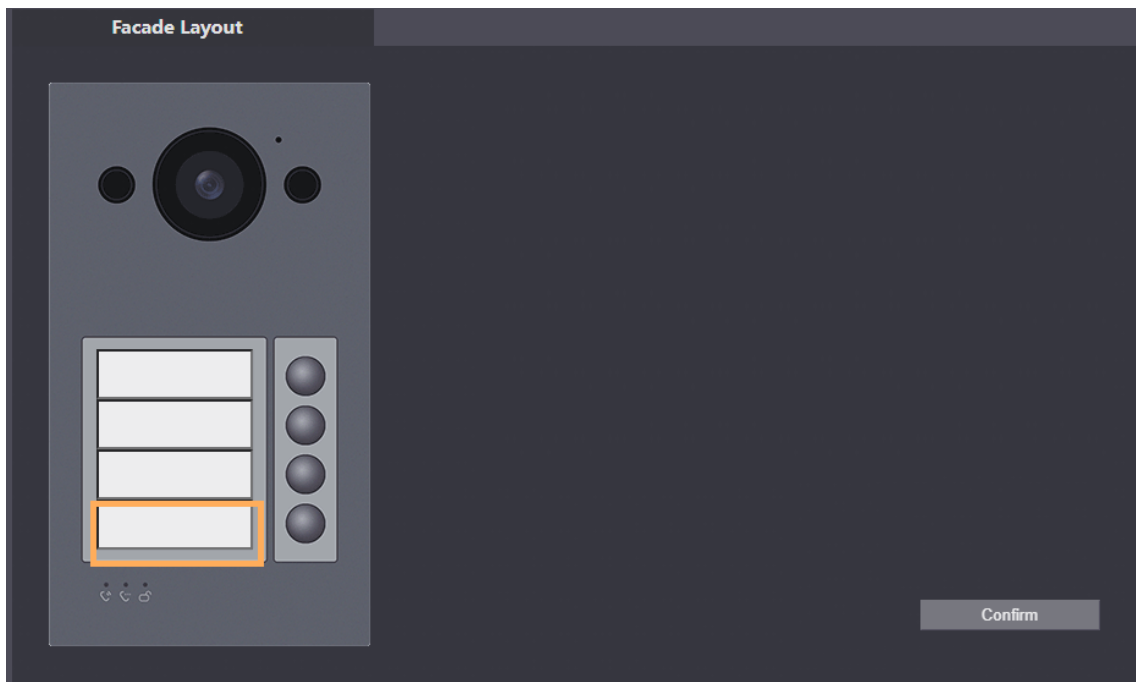
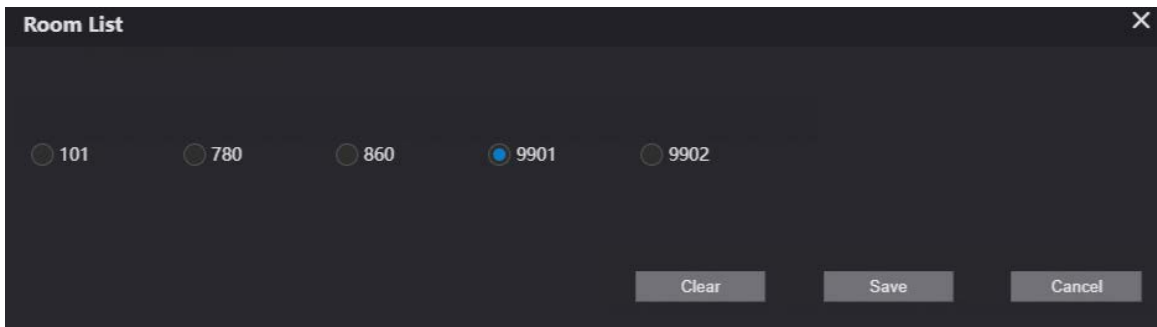

Figure 4-4 Room list



Step 4 Click **Save** to save the selected room number.

Figure 4-5 Configure the fourth nameplate



Step 5 Click **Confirm** to save all the settings.

Related Operations

If you want to bind room numbers when you install 2 buttons or 4 buttons for the VTO, repeat Step 3 to Step 4 until you have configured all of the room numbers.

4.2 Video & Audio

Configure the video format and quality, and audio of the VTO.

Step 1 Select **Local Settings > Video & Audio**.

Figure 4-6 Video

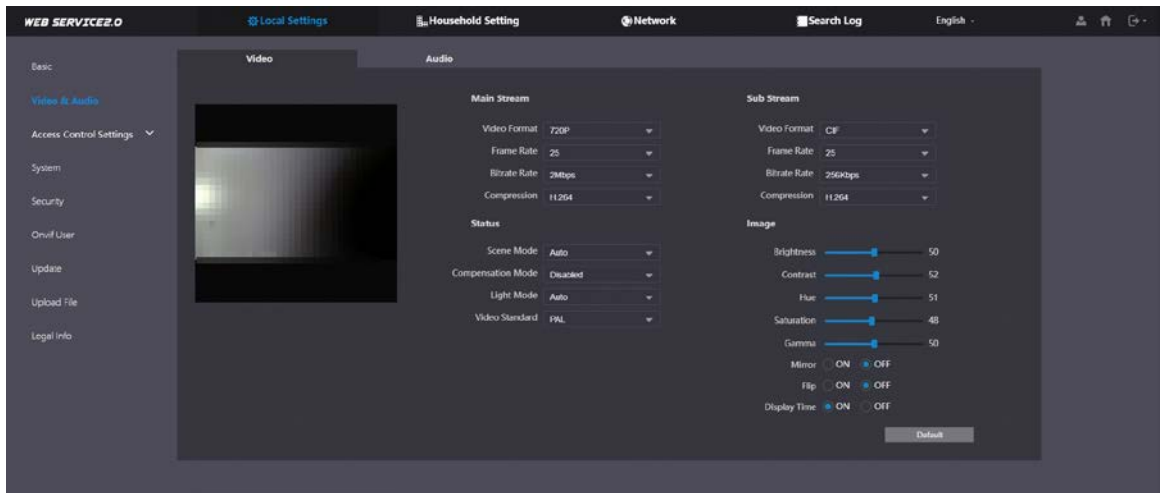
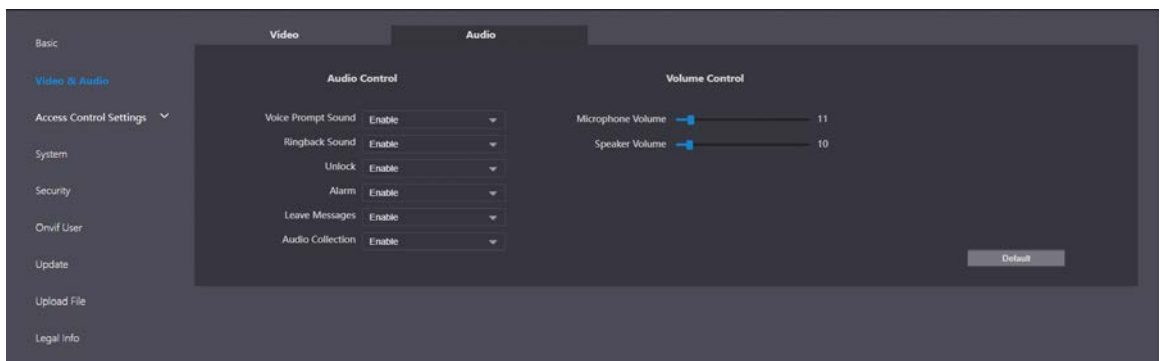





Figure 4-7 Audio



Step 2 Configure the parameters, which will take effect upon change.

Table 4-2 Video parameter description

Parameter		Description
Main Stream	Video Format	<ul style="list-style-type: none"> ● 720P: 1280 × 720. ● WVGA: 800 × 480. ● D1: 720 × 480. ● CIF: 352 × 288.
	Frame Rate	The range is 1 to 25. The larger the value, the smoother the video, but it requires more bandwidth.
	Bitrate Rate	Include 768 Kbps, 896 Kbps, 1024 Kbps, 1.25 Mbps, 1.5 Mbps, 1.75 Mbps, 2Mbps and 4 Mbps. The larger the value, the better the video quality, but it requires more bandwidth.
	Compression	<ul style="list-style-type: none"> ● H.264. ● H.265.  <p>Compared with H.264, H.265 requires smaller bandwidth.</p>
Sub Stream	Video Format	<ul style="list-style-type: none"> ● 1080P: 1920 × 1080. ● WVGA: 800 × 480. ● QVGA: 320 × 240. ● D1: 720 × 480. ● CIF: 352 × 288.

Parameter		Description
	Frame Rate	The range is 1 to 25. The larger the value, the smoother the video, but it requires more bandwidth.
	Bitrate Rate	Include 224 Kbps, 256 Kbps, 320 Kbps, 384 Kbps, 448 Kbps, 512 Kbps, 640 Kbps, 768 Kbps. The larger the value, the better the video quality, but it requires more bandwidth.
	Compression	<ul style="list-style-type: none"> • H.264. • H.265.  <p>Compared with H.264, H.265 requires smaller bandwidth.</p>
Status	Scene Mode	Select from Auto , Disabled , Sunny and Night . Auto is selected by default.
	Compensation Mode	<ul style="list-style-type: none"> • BLC: Back light compensation. Improve the clarity of the target in the image. • WDR: Wide dynamic range. Enhance the brightness of dark areas, and reduce the brightness of bright areas to improve the image. • HLC: High light compensation. Reduce the brightness of the strong spots to improve the overall image.
	Light Mode	Select from NO , NC , Auto and Scheduled .
	Video Standard	Select PAL or NTSC according to your area.  PAL is mostly used in China and Europe, and NTSC primarily in the United States and Japan.
Image	Brightness	The larger the value, the brighter the image.
	Contrast	Larger value for more contrast between bright and dark areas.
	Hue	Make the color brighter or darker. The default value is made by the light sensor, and we recommend keeping it default.
	Saturation	The larger the value, the thicker the color.
	Gamma	Changes the picture brightness and improves the picture dynamic range in a non-linear way. The larger the value, the brighter the image.
	Gain Adjustment	Amplify the video signal to increase image brightness. If the value is too large, there will be more noise in the image.
	Mirror	Display the image with left and right side reversed.
	Flip	Display the image upside down.
	Display Time	Display the current time and date on the video image.
Audio Control	Voice Prompt Sound	Turn on or off each type of sound.
	Ringback Sound	Adjust the volume as needed.
	Alarm	
	Leave Messages	

Parameter		Description
	Unlock	
	Audio Collection	
	Volume Control	
Volume Control	Microphone Volume	
	Speaker Volume	

4.3 Access Control Settings

This section introduces how to configure the two locks connected to the lock port or the RS-485 port of the VTO.

4.3.1 Local

Step 1 Select **Local Settings > Access Control Settings**.

Figure 4-8 Local

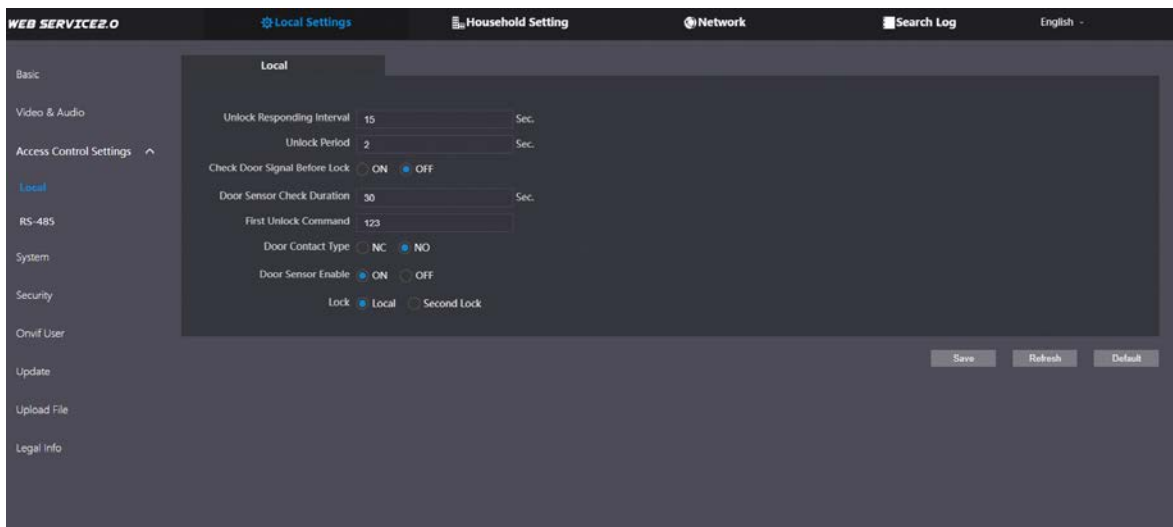

Step 2 Configure the parameters.

Table 4-3 Local access control parameter description

Parameter	Description
Unlock Responding Interval	The door can only be unlocked again after the interval.
Unlock Period	The time during which the lock stays unlocked.
Check Door Signal Before Lock	Select On or Off as needed.
Door Sensor Check Duration	If the door is unlocked longer than the Door Sensor Check Duration , the door sensor alarm will be triggered, and the alarm will be sent to the management center.  You need to install a door contact to configure this parameter.
First Unlock Command	You can connect a third-party phone, such as a SIP phone, to the VTO, and use the command to open the door remotely.
Door Contact Type	<ul style="list-style-type: none"> ● NC: Normally closed.

Parameter	Description
	<ul style="list-style-type: none"> ● NO: Normally open.
Door Sensor Enable	Synchronize door sensor status to indoor monitors (VTHs).
Lock	<ul style="list-style-type: none"> ● Local: Local lock. ● Second lock: 485 lock. Select the Lock type to unlock the lock you select.

Step 3 Click **Save**.

4.3.2 RS-485

Select **Local Settings > Access Control Settings**, and then configure the parameters of the lock connected through the RS-485 port.

Figure 4-9 Lock connected through the RS-485 port

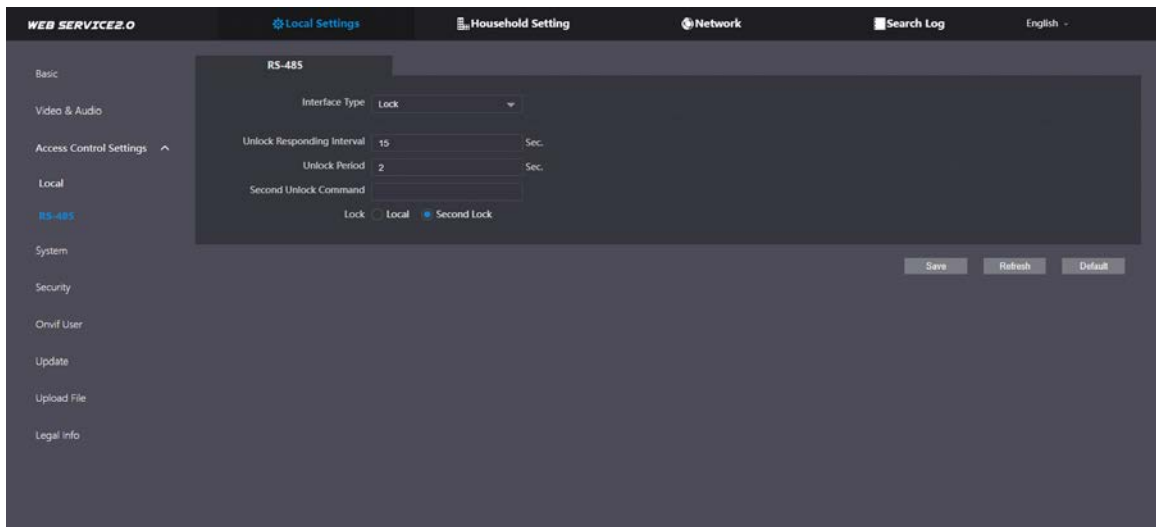

Table 4-4 RS-485 description

Parameter	Description
Interface Type	Lock by default.
Unlock Responding Interval	The door can only be unlocked again after the interval.
Unlock Period	The time during which the lock stays unlocked.
Second Unlock Command	You can connect a third-party phone, such as a SIP phone, to the VTO, and use the command to open the door remotely. The default command is 456.
Lock	Select the Lock type to unlock the lock you select. <ul style="list-style-type: none"> ● Local: Local lock. ● Second lock: 485 lock.

4.4 System

Configure time parameters, NTP server, and more.

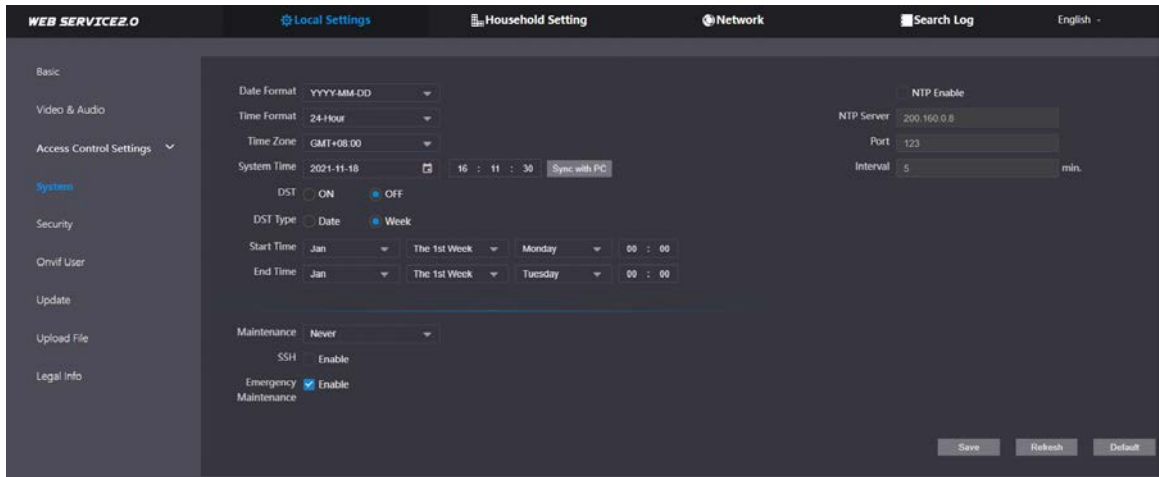

Step 1 Select **Local Settings > System**.

Figure 4-10 System



Step 2 Configure the parameters.

Table 4-5 System parameter description

Parameter	Description
Date Format	Select from one of the following: <ul style="list-style-type: none"> • YYYY-MM-DD • MM-DD-YYYY • DD-MM-YYYY
Time Format	Select from one of the following: <ul style="list-style-type: none"> • 24-Hour • 12-Hour
System Time	 Changing system time might cause problems on video searching and information publication. Turn off video recording and auto snapshot before changing it.
Time Zone	Configure the time zone as needed.
Sync with PC	Synchronize the VTO system time with your PC.
DST	Daylight saving time. If it is applicable to your area, you need to enable it, and then configure DST type, start time and end time.
DST Type	Select Date or Week as needed, and then configure the specific period.
Start Time	Configure the start time and end time of DST.
End Time	
NTP Enable	Enable NTP and enter the IP address of the NTP server, and then the VTO will synchronize time with the NTP server automatically.
NTP Server	
Port	NTP server port number.
Interval	VTO time update cycle. 30 minutes at most.
Maintenance	Define the time when the VTO will restart automatically. Choose from Never, Monday, Tuesday, Wednesday, Thursday, Friday, Saturday and Sunday.
SSH	You can connect debugging devices to the VTO through SSH protocol.  We recommend turning it off, and turn on security mode and outbound service information protection. See "4.5 Security". Otherwise, the VTO might be exposed to security risks and data leakage.
Emergency Maintenance	Enable it for fault analysis and repair.  This function will occupy 8088 and 8087 ports.
NTP Enable	Enable NTP so that the device time will be automatically synchronized with server.

Step 3 Click **Save**.

4.5 Security

Configure functions that involve device security.



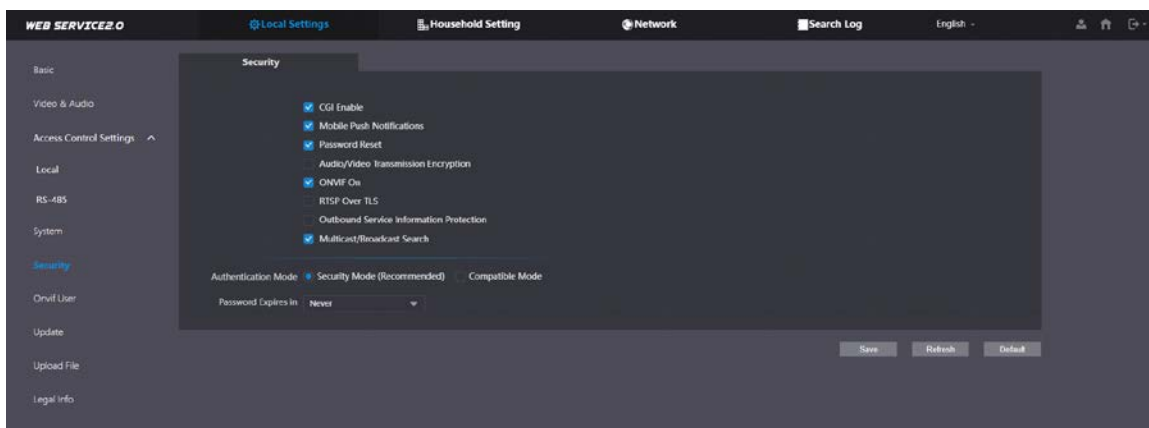

Step 1 Select **Local Settings > Security**.





Figure 4-11 Security



Step 2 Configure the parameters.

Table 4-6 Security parameter description

Parameter	Description
CGI Enable	<p>Enable the use of CGI command.</p> <p></p> <p>We recommend you turn it off. Otherwise, the VTO might be exposed to security risks and data leakage.</p>
Mobile Push Notification	<p>Send information to the app on the smartphone.</p> <p></p> <p>We recommend you turn it off if you do not need this function. Otherwise, the VTO might be exposed to security risks and data leakage.</p>
Password Reset	<p>If turned off, you will not be able to reset password.</p>
Audio/Video Transmission Encryption	<p>Encrypt all data during voice or video call.</p> <p></p> <p>We recommend you turn it on. Otherwise, the VTO might be exposed to security risks and data leakage.</p>
ONVIF On	<p>Allow third-party to pull video stream of the VTO through the ONVIF protocol.</p> <p></p> <p>We recommend turning it off. Otherwise, the VTO might be exposed to security risks and data leakage.</p>
RTSP Over TSL	<p>Output encrypted bit stream through RTSP.</p> <p></p> <p>We recommend you turn it on. Otherwise, the VTO might be exposed to security risks and data leakage.</p>
Outbound Service Information Protection	<p>Protect your passwords.</p>

Parameter	Description
	 <p>We recommend you turn it on. Otherwise, the VTO might be exposed to security risks and data leakage.</p>
Multicast/Broadcast Search	<p>Enable it and the VTO will be found by other devices.</p>  <p>We recommend you turn it off. Otherwise, the VTO might be exposed to security risks and data leakage.</p>
Authentication Mode	<ul style="list-style-type: none"> ● Security Mode (recommended): Support logging in with Digest authentication. ● Compatible Mode: Use the old login method.  <p>We recommend you use the security mode. Compatible mode might expose the VTO to security risks and data leakage.</p>
Password Expires in	<p>Select an expiration period.</p>  <p>We recommend you do not use never. The VTO might be exposed to security risks and data leakage if you chose that one.</p>

Step 3 Click **Save**.

4.6 Onvif User

Add accounts for devices to monitor the VTO through the ONVIF protocol.



The operation of deleting an account cannot be undone.

Step 1 Select **Local Settings > Onvif User**.

Figure 4-12 Onvif user

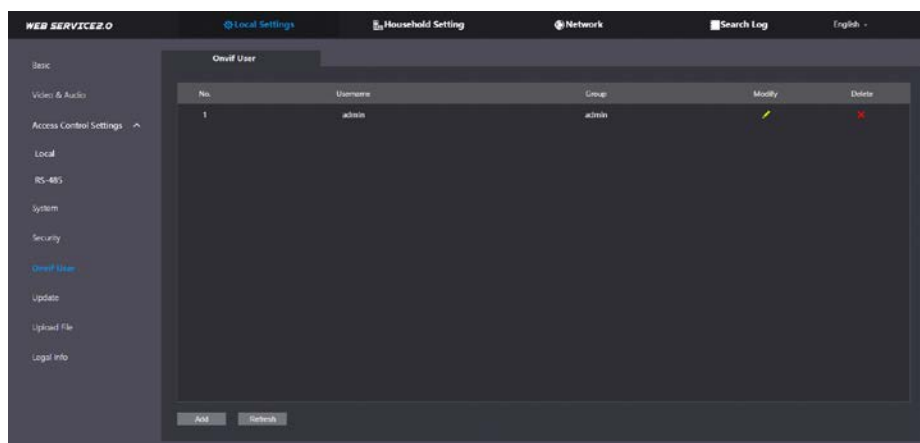

Step 2 Click **Add**.

Figure 4-13 Add an Onvif user

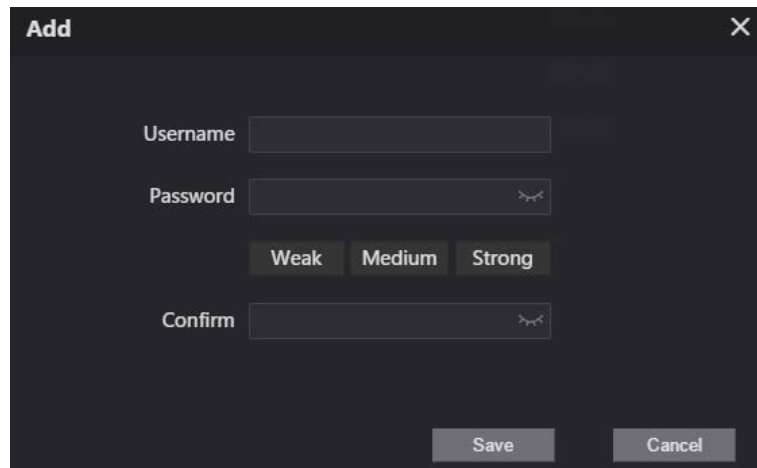

The screenshot shows a dark-themed dialog box titled "Add" with a close button (X) in the top right corner. It contains three input fields: "Username", "Password", and "Confirm". The "Password" and "Confirm" fields have a small icon on the right side. Below the "Password" field, there are three buttons labeled "Weak", "Medium", and "Strong". At the bottom of the dialog, there are two buttons: "Save" and "Cancel".

- Step 3** Enter the information, and then click **Save**.
Onvif devices can now monitor the VTO by using the account.

4.7 Updating

Step 1 Select **Local Settings > Update**.

Step 2 Select ways to check the update.

- **Auto Check:** Select the function to check automatically whether there is a new system version.
- **Manual Check:** Select the function to check whether there is a new system version.

Figure 4-14 Update

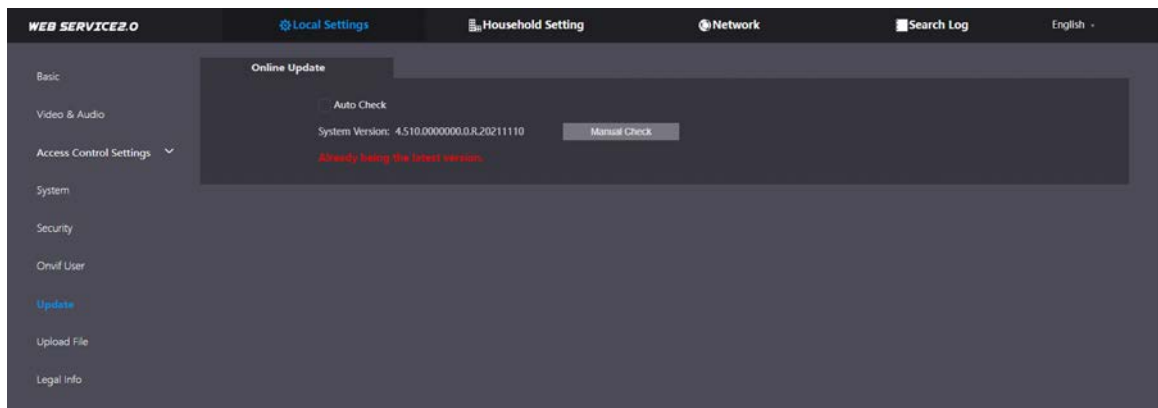

4.8 Uploading File

Upload audio file to change the sound when calling, unlocking the door, and more.

Step 1 Select **Local Settings > Upload File**.

Step 2 Select an audio type from the drop-down list, and then click **Browse** to select the audio file.

Figure 4-15 Change sound prompt

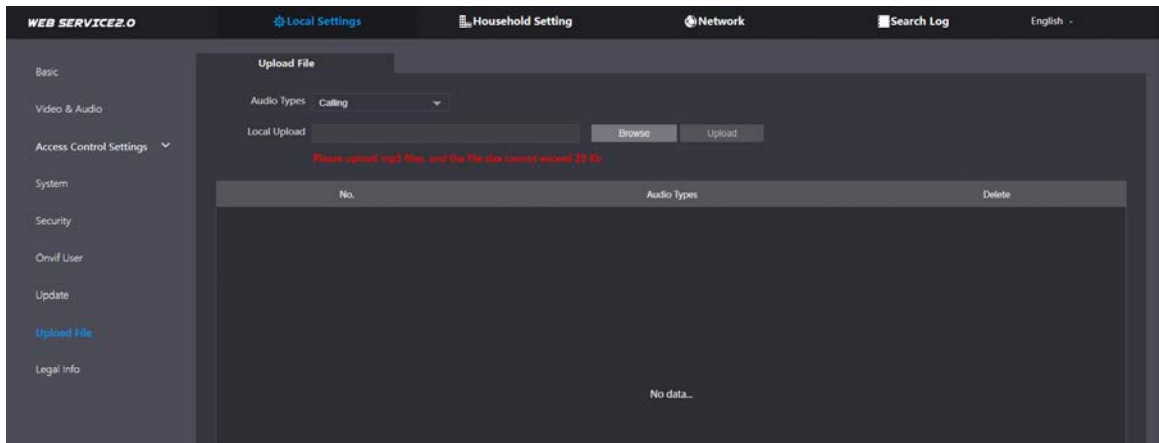

Step 3 Click **Upload**.

4.9 Legal Information

You can view related legal information notices in this section.

Figure 4-16 Legal information

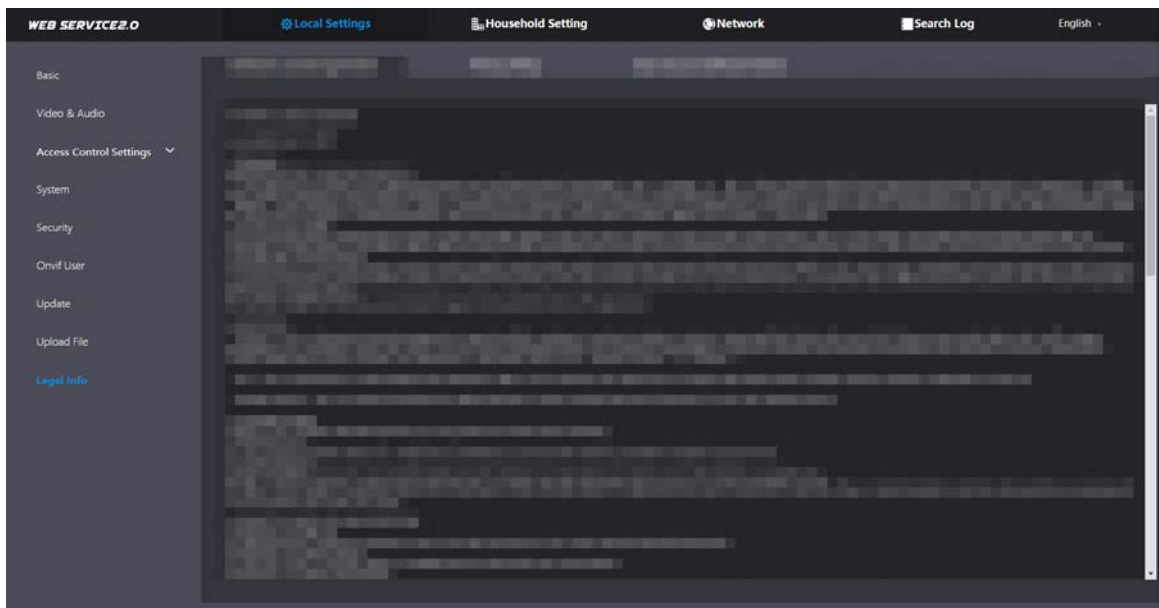

5 Household Setting

This chapter introduces how to add, modify, and delete VTO, VTH, VTS, and IPC, and how to send messages from the SIP server to VTOs and VTHs when the VTO works as the SIP server. If you are using other servers as the SIP server, see the corresponding manual for details.

5.1 VTO No. Management

You can add VTOs to the SIP server, and all the VTOs connected to the same SIP server can call each other.

Step 1 Log in to the web page of the VTO that works as the SIP server.

Step 2 Select **Household Setting > VTO No. Management**.

Figure 5-1 VTO management

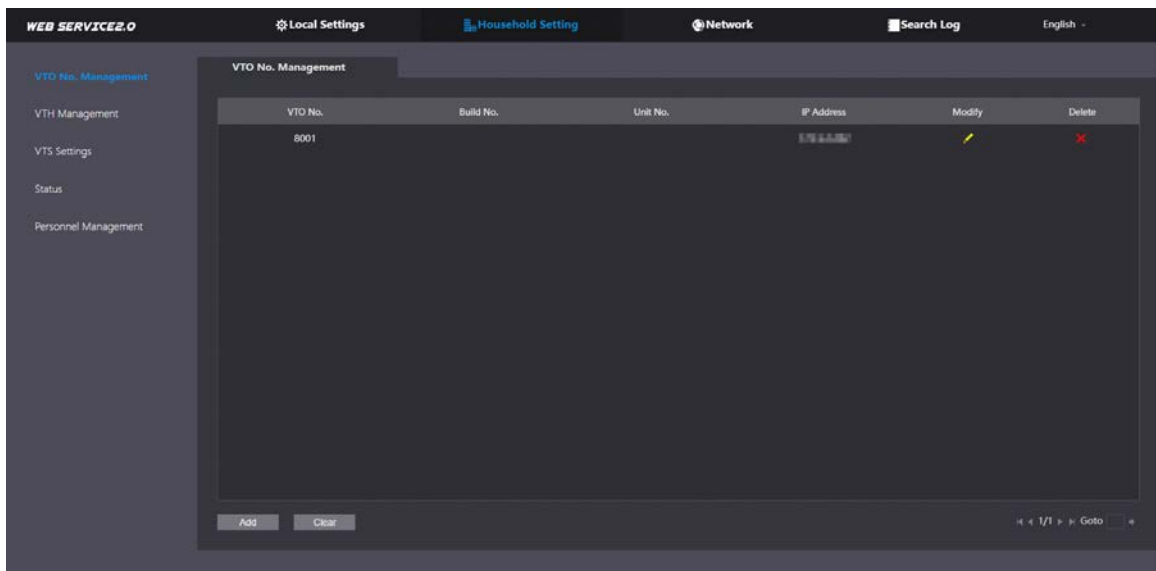

Step 3 Click **Add**.

Figure 5-2 Add VTO

The 'Add' dialog box is shown with a dark background and a close button (X) in the top right corner. It contains the following fields:

- No. (empty text input)
- Registration Password (password input with masked characters '*****' and a visibility toggle icon)
- Build No. (empty text input)
- Unit No. (empty text input)
- IP Address (text input with the value '127.0.0.1')
- Username (empty text input)
- Password (password input with masked characters and a visibility toggle icon)

At the bottom of the dialog, there are 'Save' and 'Cancel' buttons.

Step 4 Configure the parameters.





The SIP server must be added.

Table 5-1 Add VTO configuration

Parameter	Description
No.	The VTO number you configured.
Registration Password	Leave it as default.
Build No.	Available only when the platform servers work as the SIP server.
Unit No.	
IP Address	IP address of the VTO.
Username	Username and password used to log in to the web page of the VTO.
Password	

Step 5 Click **Save**.



Click  or  to modify or delete a VTO, or **Clear** to delete all added VTOs, but the one that you have logged in to cannot be modified or deleted.

5.2 VTH Management

You can add room numbers to the SIP server, and then configure the room number on the VTHs to connect them to the network.

Step 1 Log in to the web page of the SIP server.

Step 2 Select **Household Setting > VTH Management**.

Figure 5-3 Room number management

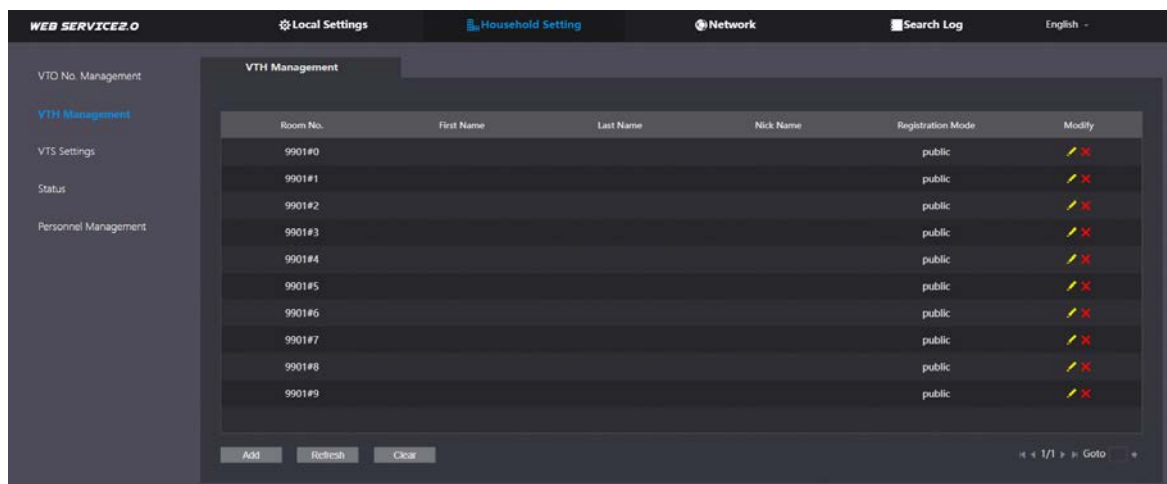

Step 3 Click **Add**.

Figure 5-4 Add a room number

Step 4 Configure the parameters.

Table 5-2 Room information

Parameter	Description
First Name	Enter the information you need to differentiate each room.
Last Name	
Nick Name	
Room No.	Enter a room number, and then configure the number on a VTH to connect to connect it to the network.
Registration Type	Select public .
Registration Password	Leave it as default.

Step 5 Click **Save**.



Click  or  to modify or delete a room number.

5.3 Personnel Management

Adding personnel information.

Card issuing

Issue an access card to unlock the door of a room.



To use this function, the VTO must have a card reader.

Step 1 Log in to the web page of the VTO.

Step 2 Select **Household Setting > Personnel Management**.

Figure 5-5 Personnel management

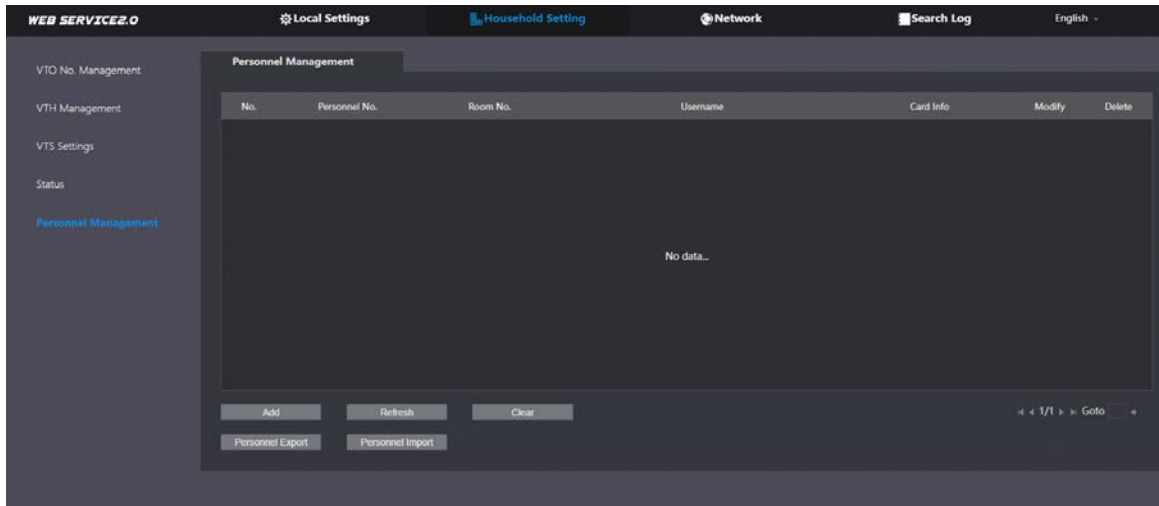

Step 3 Click **Add**.

Figure 5-6 Add personnel information

Personnel No.

Room No.

Username

Unlock Permission Lock 1 Lock 2

Save Cancel

Step 4 Enter the parameters, and then click **Save**.

- Lock1: Local lock.
- Lock 2: 485 lock.



Only models that have 485 ports support 2 types of locks.

Figure 5-7 Operation succeed

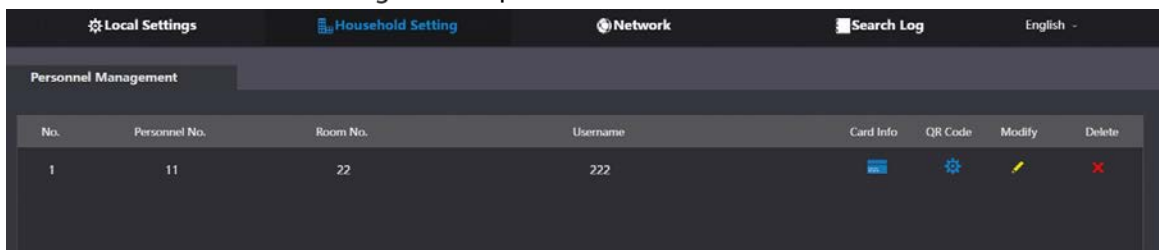

Step 5 Click  to go to the card issuing window.



For some VTO models, the QR code is embedded in the **Personnel Management** page. Yet for some models, you need to go to **Network > Basic > Cloud Service** to check the QR code.

Figure 5-8 Card issuing window

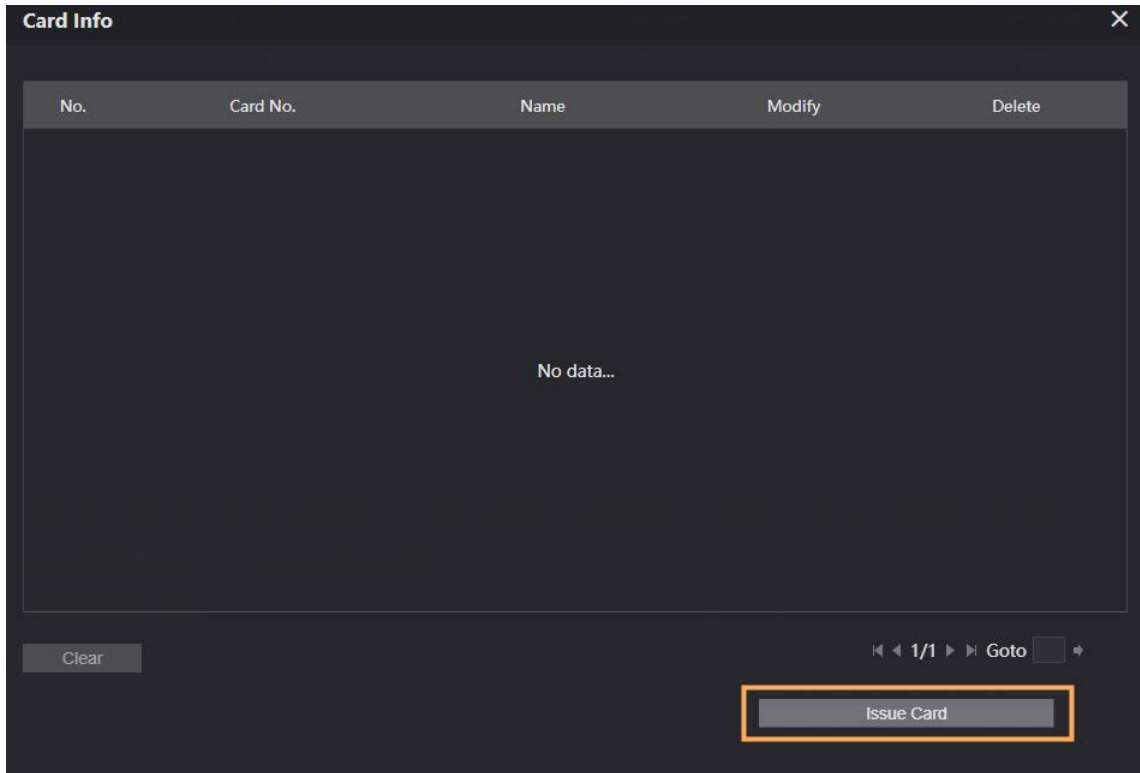

Step 6 Click **Issue Card** to issue cards.

Step 7 The web page displays the countdown prompt (120 s). Once the countdown starts, you need to swipe the card on the card reader of the VTO within this time period. After the swiping, the card number will be automatically recognized by the VTO.

Figure 5-9 Countdown in process

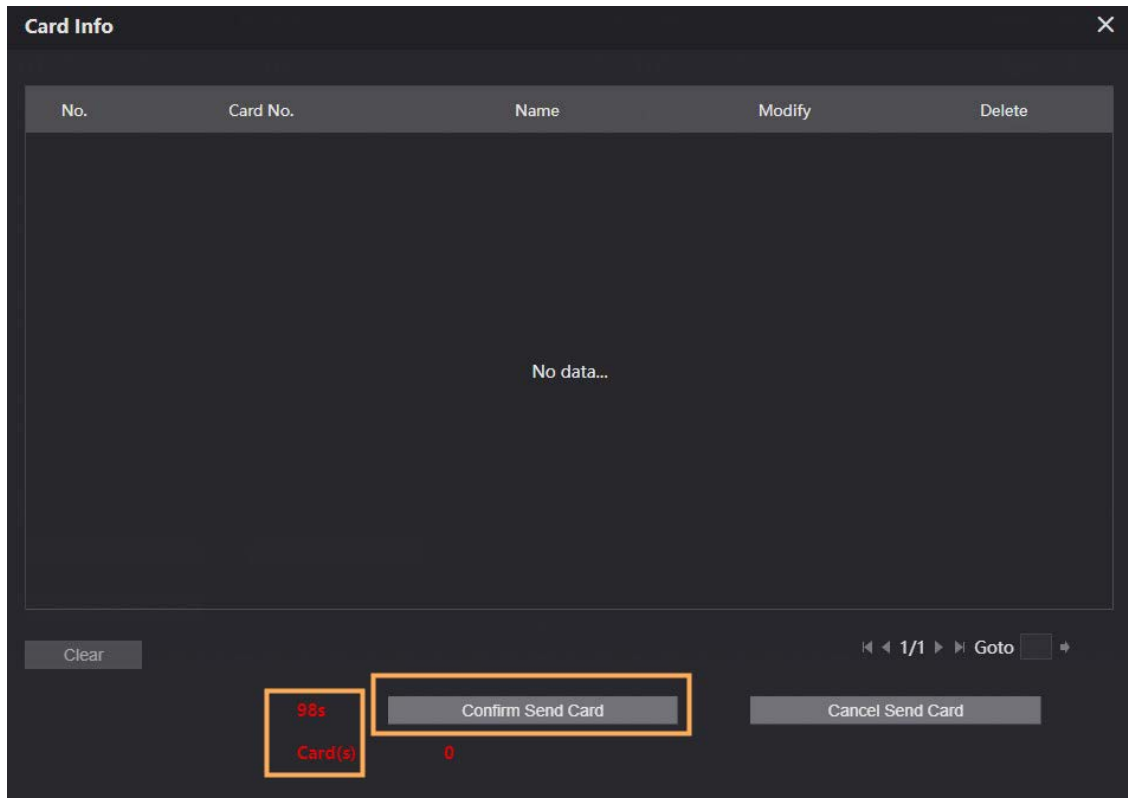



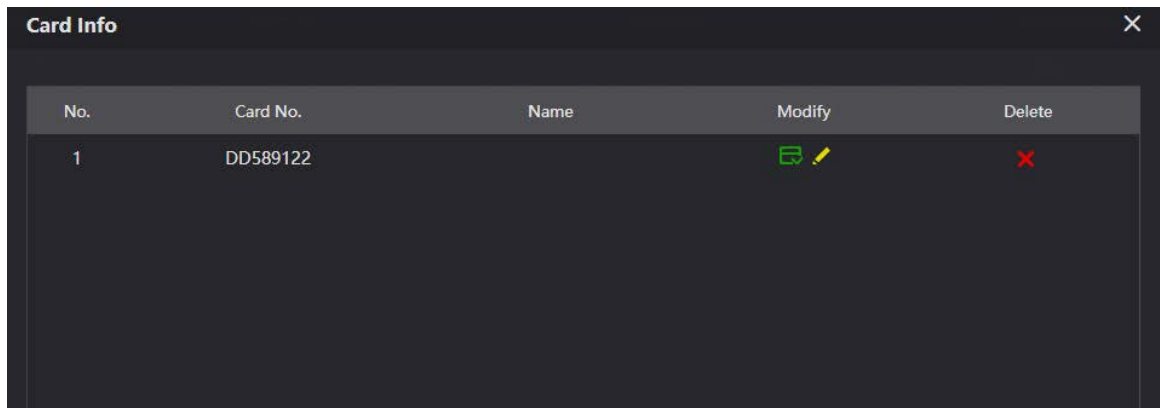

Step 8 Click **Confirm Send Card** after swiping to complete the issuing process.

Figure 5-10 Newly issued Cards



No.	Card No.	Name	Modify	Delete
1	DD589122			

Other Operations

- Click  to set it to loss, and then the icon changes to . The lost card cannot be used to open the door.
- Click  or  to modify the username or delete the card.

5.4 VTS Management

You can add a VTS to the SIP server, and then it can be used as the management center. It can also manage, call, or receive calls from all the VTOs and VTHs in the network. See the corresponding user's manual for details.

Step 1 Log in to the web page of the VTO that works as the SIP server.

Step 2 Select **Household Setting > VTS Settings**.

Figure 5-11 VTS management

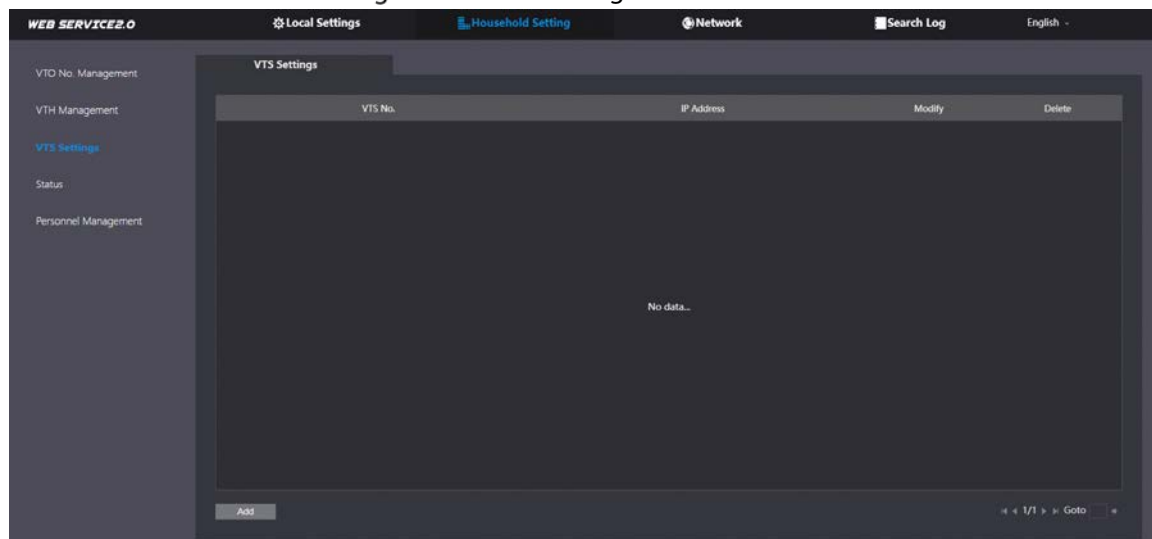

The screenshot shows the 'VTS Settings' page. The top navigation bar includes 'Local Settings', 'Household Setting', 'Network', 'Search Log', and 'English'. The left sidebar lists 'VTO No. Management', 'VTH Management', 'VTS Settings' (highlighted), 'Status', and 'Personnel Management'. The main content area has a table with columns 'VTS No.', 'IP Address', 'Modify', and 'Delete'. The table is currently empty, displaying 'No data...'. An 'Add' button is located at the bottom left of the table area, and a pagination control '1/1' is at the bottom right.

Step 3 Click **Add**.

Figure 5-12 Add VTS

Step 4 Configure the parameters.

Table 5-3 Add VTS configuration

Parameter	Description
VTS No.	The number of the VTS.
Registration Password	Leave it as default.
IP Address	VTS IP address.

Step 5 Click **Save**.

5.5 Status

You can view the online status and IP addresses of all the connected devices.

Log in to the web home page of the SIP server, and then select **Household Setting > Status**.

Figure 5-13 Status

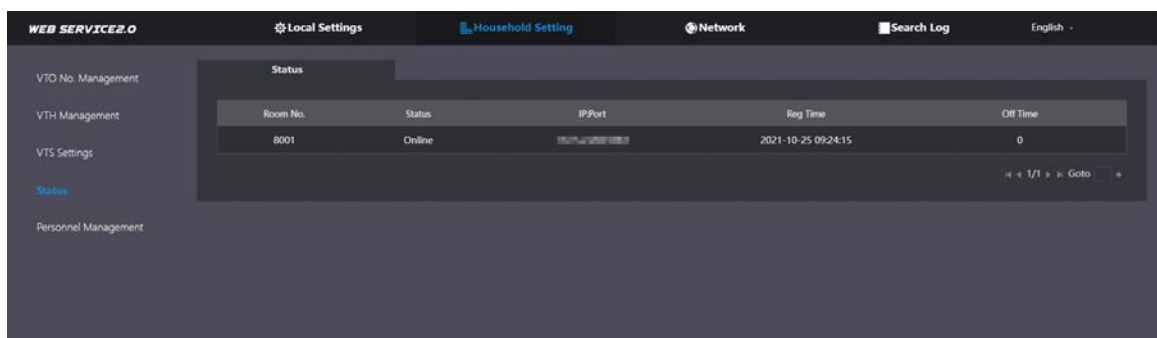

6 Network

This chapter introduces how to configure the network parameters.

6.1 Basic

6.1.1 TCP/IP

You need to configure the TCP/IP information to connect the VTO to the network. The descriptions below are for models with a Wireless LAN card. A Wireless LAN device is optional.

Wireless LAN

- Step 1 Log in to the web page of the VTO.
- Step 2 Select **Network** > **Basic**.
- Step 3 Configure the TCP/IP parameters in the **WLAN** section.

LAN

- Step 1 Log in to the web page of the VTO.
- Step 2 Select **Network** > **Basic**.
- Step 3 Configure the TCP/IP parameters in the **LAN** section.

Figure 6-1 Network configuration

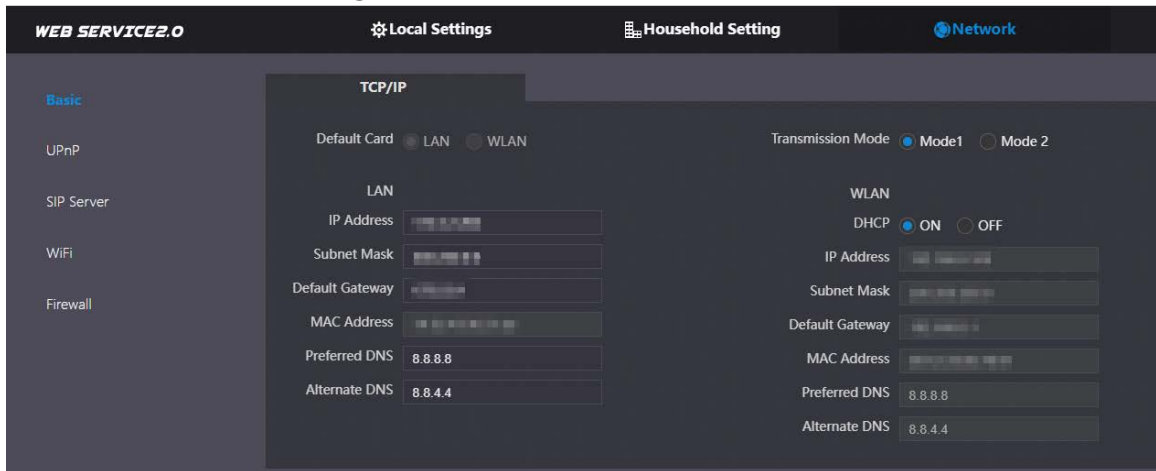



Table 6-1 Parameter description

Parameter	Description
IP Address	Your planned IP address for the VTO.
Preferred DNS	It is 8.8.8.8 by default.
Alternate DNS	It is 8.8.4.4 by default.

Parameter	Description
Transmission Mode	<p>Choose the transmission mode based on your actual needs.</p> <ul style="list-style-type: none"> Mode 1: Multicast streaming (UDP). Mode 2: RTSP streaming (TCP).  <p>Mode 2 is preferred when the switch does not support multicast function, or when the network connection is not good.</p>
DHCP	Enable the function to get the allocated IP address for the VTO.

6.1.2 Port

Figure 6-2 Port

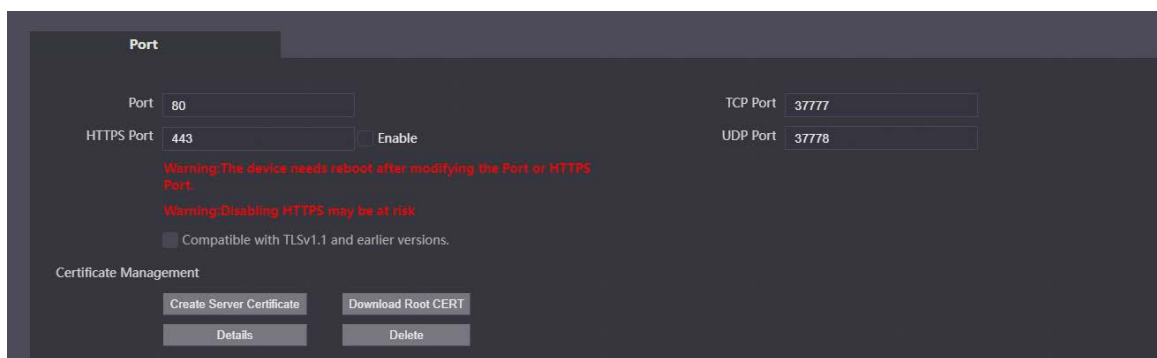



Table 6-2 Parameter description

Parameter	Description
Port	80 by default. If already used, choose any number from 1025 to 65535 as needed. You can enter <i>http://VTO IP address: Port</i> to log in to the VTO.
HTTPS Port	Enable it and click Save . You can now enter <i>https://VTO IP address: HTTPS Port</i> to log in to the VTO.
TCP/UDP Port	Used for accessing the VTO with devices in other networks. See "6.2 UPnP" for details.
Create Server Certificate	<p>The unique digital identification of VTO for the SSL protocol. For first time use or after changing the IP address of the VTO, you need to go through this process.</p>  <p>If you delete the certificate that has been created, it cannot be undone.</p>
Download Root CERT	<p>If you are using a PC that has never logged in to the VTO, you need to download the root certificate, double-click to install it, and then you can use the HTTPS function mentioned above.</p>  <p>If you delete the certificate that has been installed, it cannot be undone.</p>

6.1.3 Cloud service

Figure 6-3 Cloud service



Enable the Cloud Service function, and then you can scan the QR code with your phone to add the VTO to the app on your smartphone.



For some VTO models, the QR code is embedded in the **Cloud Service** module. Yet for some models, you need to go to **Household Setting > Personnel Management** to check the QR code.

6.2 UPnP

When the VTO works as the SIP server, you can configure the UPnP function to allow WAN devices to log in to the VTO.

Figure 6-4 UPnP

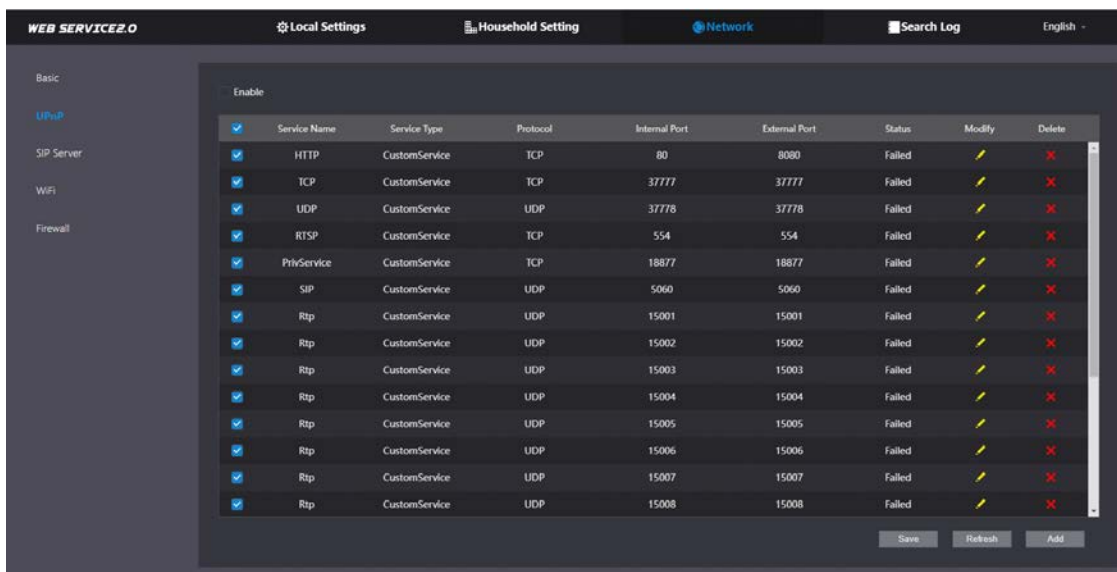

Preparation

- Enable the UPnP function on the router, and then configure a WAN IP address for the router.
- Connect the VTO to the LAN port of the router.

6.2.2 Enabling UPnP Services

Step 1 Select **Network > UPnP**.

Step 2 Enable the services listed.

Step 3 Select **Enable**.

Step 4 Click **Save**.

6.2.3 Adding UPnP Services

Step 1 Select **Network > UPnP**.

Step 2 Click **Add**.

Step 3 Configure the parameters as needed.

Figure 6-5 Add a UPnP service

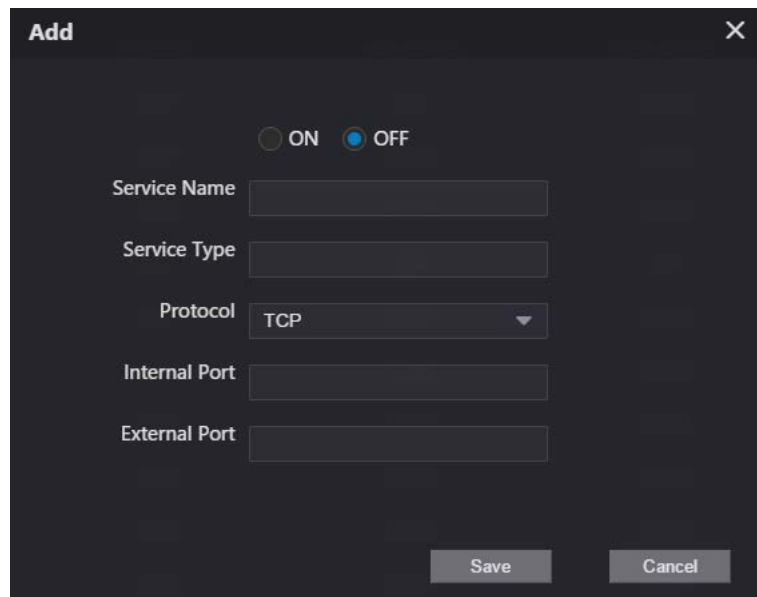



Table 6-3 Parameter description

Parameter	Description
Service Name	Enter the information as needed.
Service Type	
Protocol	Select TCP or UDP .
Internal Port	Use port number from 1024 through 5000.
External Port	 <ul style="list-style-type: none">Do not use port number 1–1023 to avoid conflict.If you need to configure this function for multiple devices, make sure that the ports are not the same.The port number you use must not be occupied.The internal and external port number must be the same.

6.3 SIP Server

There must be a SIP server in the network for all connected VTOs and VTHs to call each other. You can use a VTO or other servers as the SIP server.

Step 1 Select **Network > SIP Server**.

Step 2 Select a server type.

- The VTO you have logged in as the SIP server:
Enable **SIP Server**, and click **Save**. You can add VTOs and VTHs to this VTO. See the details in "5 Household Setting".



If the VTO you have logged in does not work as the SIP server, do not enable **SIP Server**; otherwise the connection will fail.

- If another VTO works as the SIP server:
Do not enable **SIP server**. Set **Server Type** to **VTO**, configure the parameters, and then click **Save**.

Figure 6-6 VTO as the SIP server

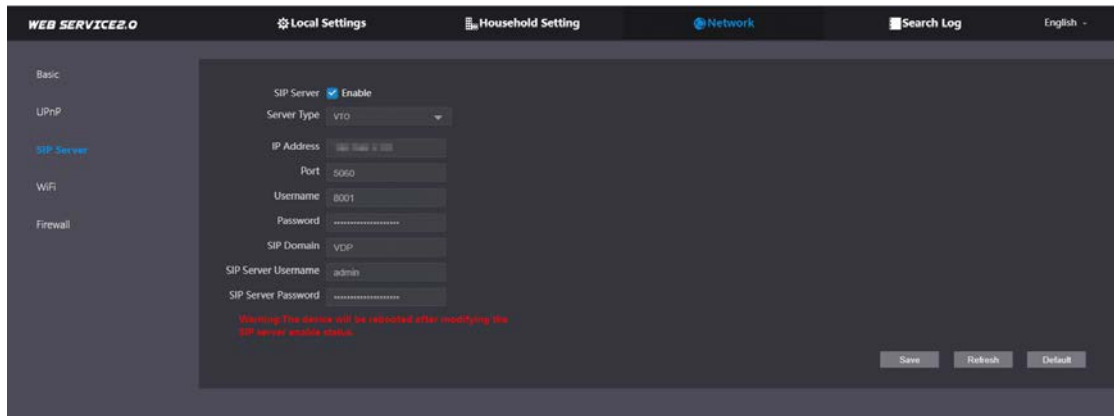

Table 6-4 SIP server configuration (VTO as the SIP server)

Parameter	Description
IP Addr.	Your planned IP address of the VTO.
Port	5060 by default when a VTO works as the SIP server.
Username	Leave it as default.
Password	
SIP Domain	Leave it as default.
SIP Server Username	Username and password used to log into the web page of the SIP server.
SIP Server Password	

- If the platform works as the SIP server:
Set **Server Type** as **DSS Express/DSS Pro**, and configure the parameters, and then enable the **SIP Server**.

Figure 6-7 Platform as the SIP server

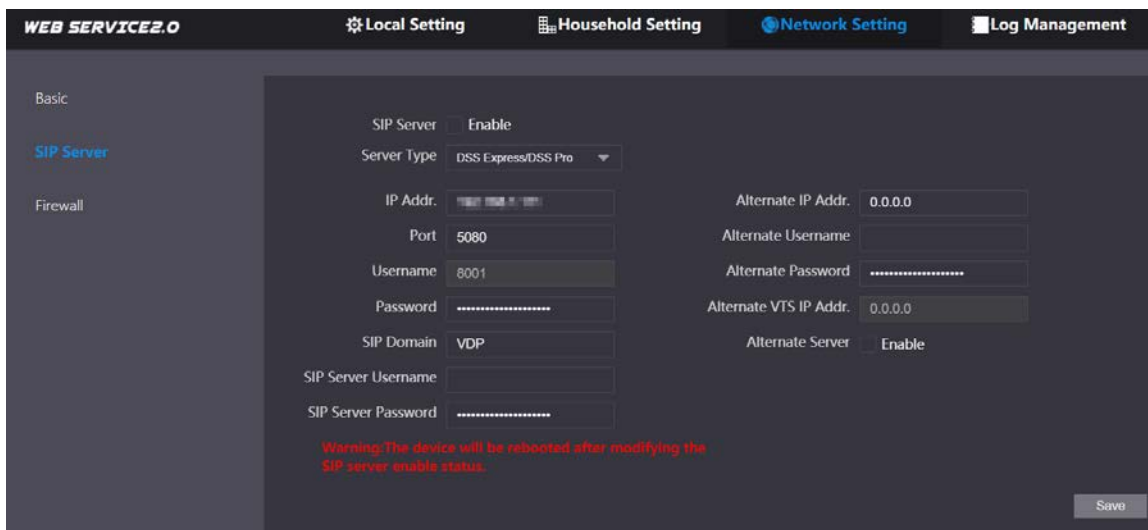



Table 6-5 SIP server description (platform as the SIP server)

Parameter	Description
IP Addr.	IP address of the SIP server.
Port	5080 by default when the platform works as the SIP server.
Username/Password	Leave it as default.
SIP Domain	Leave it as default.
SIP Server Username/ Password	Used to log in to the SIP server.
Alternate IP Addr.	<p>The alternate server will be used as the SIP server when Express/DSS stops responding. We recommend you configure the alternate IP address.</p> <p></p> <ul style="list-style-type: none"> If you enable Alternate Server, the current VTO you have logged in serves as the alternate server. If you want another VTO serve as the alternate server, you need to enter the IP address of that VTO in the Alternate IP Addr. textbox. Do not enable Alternate Server in this case.
Alternate Username/ Password	Used to log in to the alternate server.
Alternate VTS IP Addr.	IP address of the alternate VTS.
Alternate Server	Enable it as needed.

6.4 Wi-Fi

If the VTO supports Wi-Fi function, then configure the parameters here.

Figure 6-8 Wi-Fi

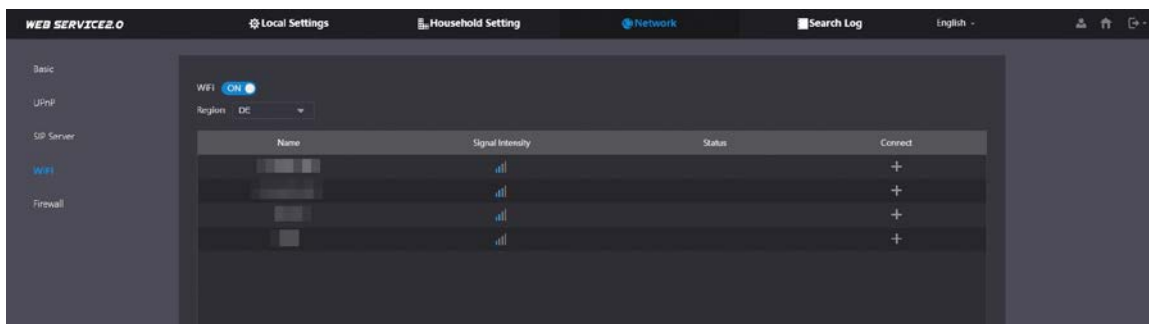

- Step 1** Select **Network > Wi-Fi**.
- Step 2** Set the **WiFi** status as **On**.
- Step 3** Select a region, and all the networks available in this region are displayed.
- Step 4** Click **+** to connect to the network that you chose.

6.5 Firewall

You can enable different firewall types to control network access to the VTO.

- Step 1** Select **Network > Firewall**.

Figure 6-9 Firewall

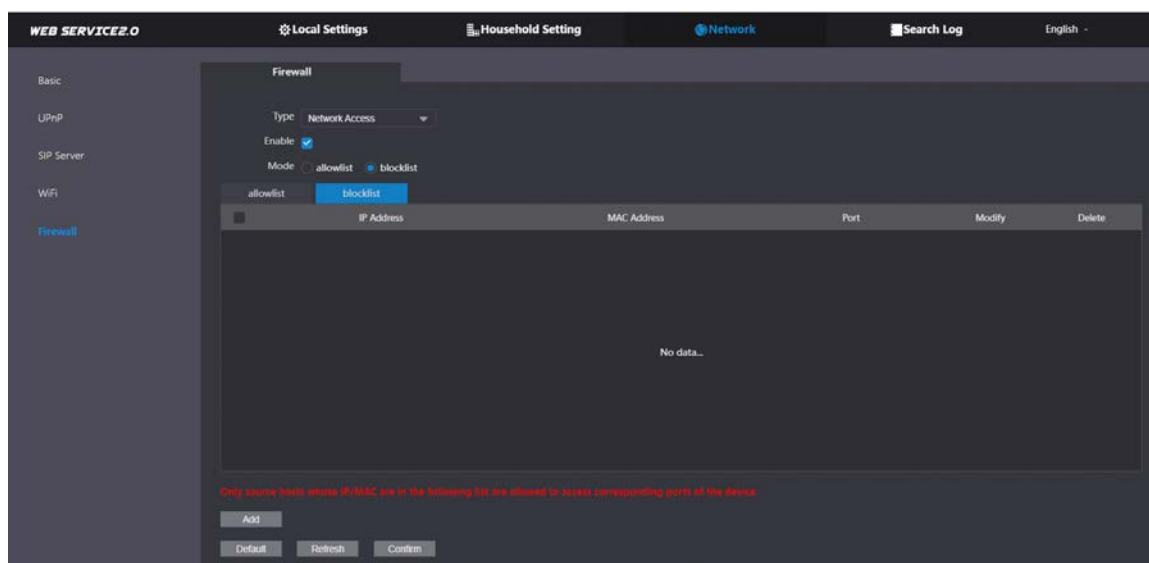

- Step 2** Select **Type**, and then enable it.
- Step 3** Configure the parameters.
- Step 4** Click **Confirm**.

Table 6-6 Firewall type description

Type	Description
Network Access	Select either Allowlist or Blocklist , and then add an IP address or segment which is allowed or denied to access the VTO.
PING Prohibited	The VTO will not response to ping to avoid ping attacks.
Anti-semijoin	Protects the VTO performance by blocking excessive SYN packets.
Mode	Allowlist: Devices that have been granted an access. Blocklist: Devices that have been forbidden an access.

7 Log Management

Select **Search Log**. You can search for different logs, and export them to your PC as needed.



If storage is full, the oldest records will be overwritten. Back up the records in time.

7.1 Call

Figure 7-1 Call

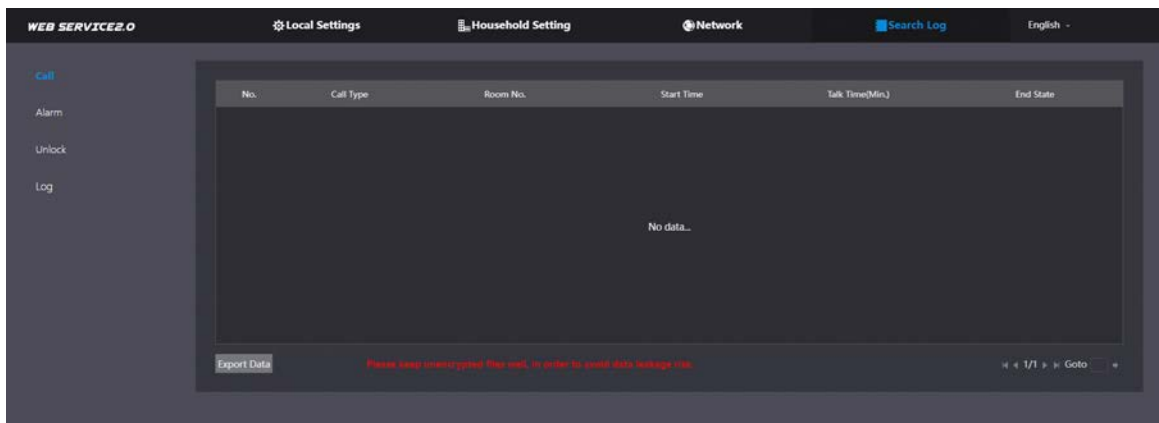

7.2 Alarm

Figure 7-2 Alarm

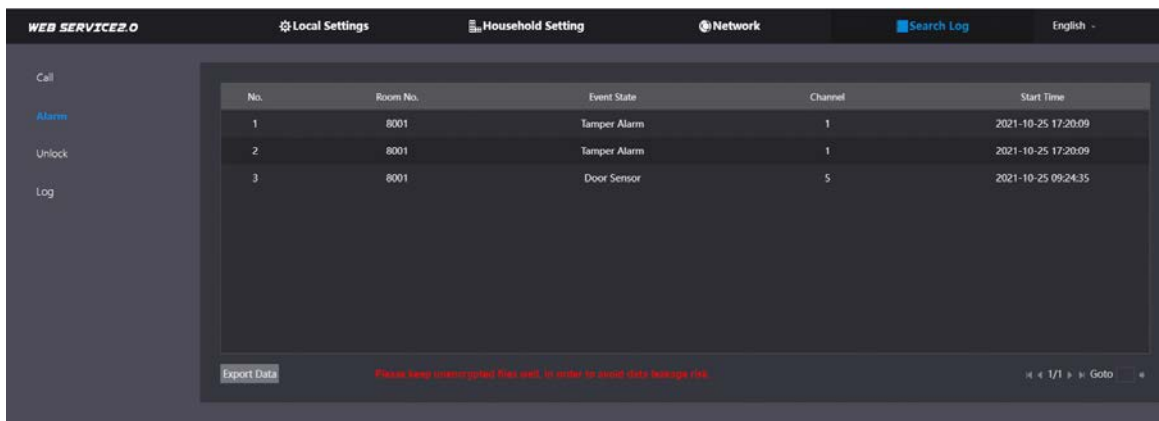

7.3 Unlock

Figure 7-3 Unlock

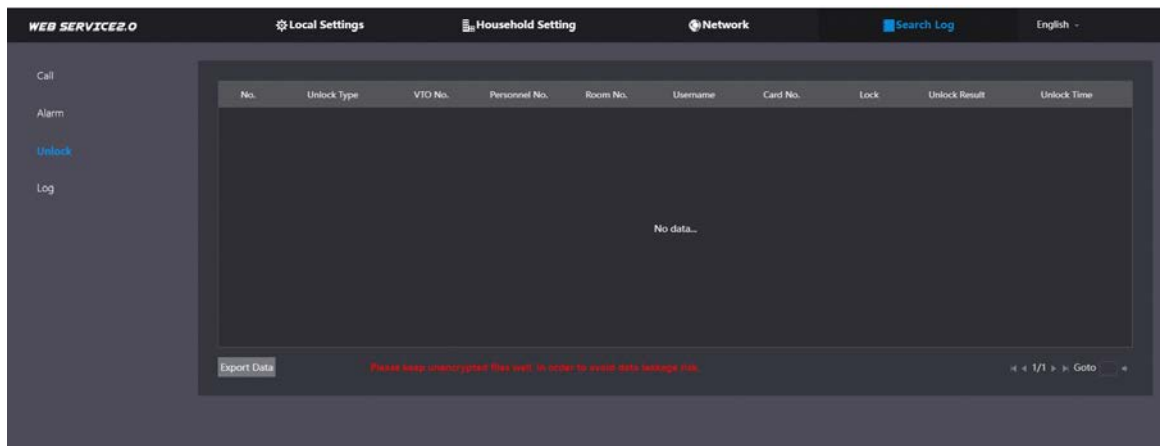

7.4 Log

Select time range and type, and then you can see all the log information.

Figure 7-4 Log

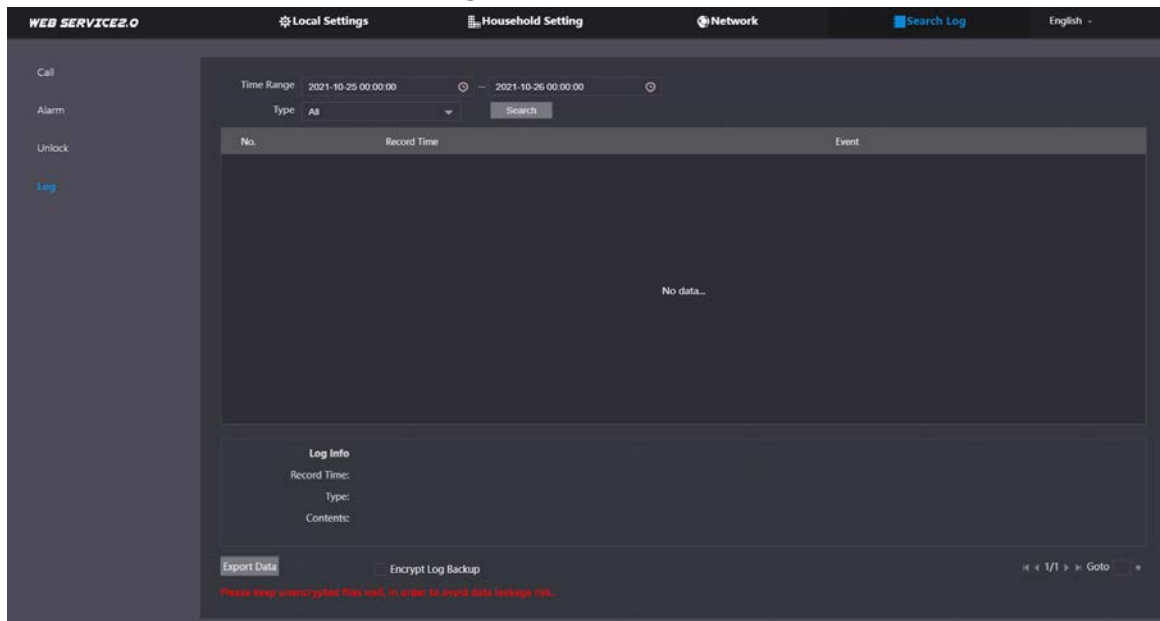

8 Button Model Configuration

The button model can be connected to the VTH to work as an alarm input button. Press the button on the front panel of the model, and then the VTH receives an alarm signal.

8.1 Cable Connection

Connect the KEY port of the button model to any one of the alarm input ports of the indoor monitor (VTH) with a cable thread.

Figure 8-1 Cable connection

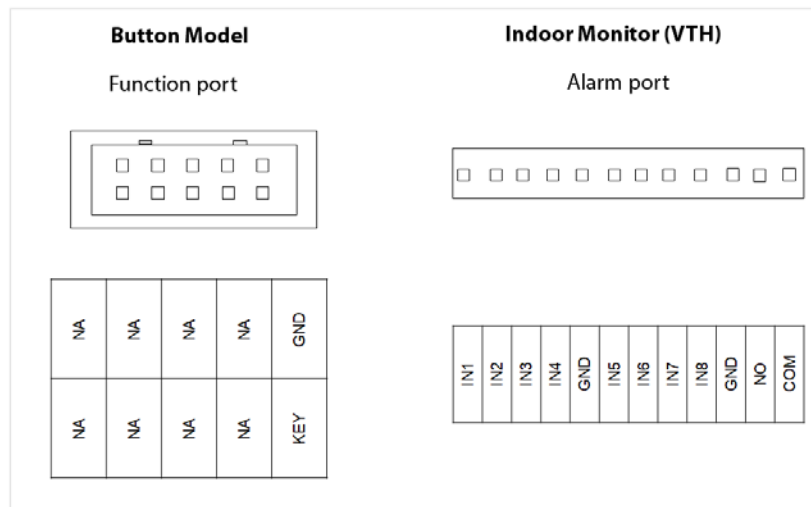

8.2 VTH Configuration

After completing cable connection, you need to set the **wired zone type** as **Doorbell** on the VTH to receive alarm signals once you press the button model.

Step 1 Power on the VTH.

Step 2 Tap **Setting > Alarm > Wired Zone** on the VTH.

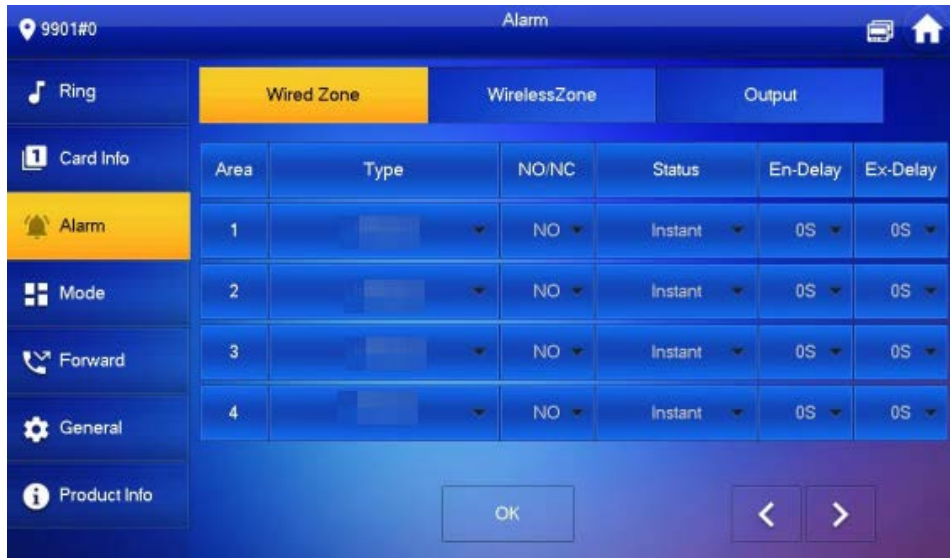

Figure 8-2 Wired zone setting



Step 3 Set the **Type** as **Doorbell**, and configure the rest of the parameters.

Step 4 Tap OK to complete setting.

Table 8-1 Parameter description

Parameter	Description
Area	The number cannot be modified.
NO/NC	Select NO (normally open) or NC (normally closed) according to detector type. It must be the same as detector type.
Type	Select corresponding type according to detector type, including IR, gas, smoke, urgency btn, door, burglar alarm, perimeter and doorbell.
Status	<ul style="list-style-type: none"> ● Instant Alarm: After armed, if an alarm is triggered, the device produces siren at once and enters alarm status. ● Delay Alarm: After armed, if an alarm is triggered, the device enters alarm status after a specified time, during which you can disarm and cancel the alarm. ● Bypass: Alarm will not be triggered in the area. After disarmed, this area will restore to normal working status. ● Remove: The area is invalid during arm/disarm. ● 24 Hour: Alarm will be triggered all the time in the area regardless of arm or disarm. <p> A zone in Remove status cannot be bypassed.</p>
Enter Delay	<p>After entering delay, when armed area triggers an alarm, entering armed area from non-armed area within the delay time period will not lead to linkage alarm. Linkage alarm will be produced if delay time comes to an end and it is not disarmed.</p> <p> Delay is only valid to the areas of Delay Alarm.</p>
Exit Delay	<p>After arm, Delay Alarm area will enter arm status at the end of Exit Delay.</p> <p> If multiple areas set the exit delay, screen prompt will conform to maximum delay time.</p>

Appendix 1 Cybersecurity Recommendations

Mandatory actions to be taken for basic device network security:

1. Use Strong Passwords

Please refer to the following suggestions to set passwords:

- The length should not be less than 8 characters;
- Include at least two types of characters; character types include upper and lower case letters, numbers and symbols;
- Do not contain the account name or the account name in reverse order;
- Do not use continuous characters, such as 123, abc, etc.;
- Do not use overlapped characters, such as 111, aaa, etc.;

2. Update Firmware and Client Software in Time

- According to the standard procedure in Tech-industry, we recommend to keep your device (such as NVR, DVR, IP camera, etc.) firmware up-to-date to ensure the system is equipped with the latest security patches and fixes. When the device is connected to the public network, we recommend enabling the "auto-check for updates" function to obtain timely information of firmware updates released by the manufacturer.
- We suggest that you download and use the latest version of client software.

"Nice to have" recommendations to improve your device network security:

1. Physical Protection

We suggest that you perform physical protection to device, especially storage devices. For example, place the device in a special computer room and cabinet, and implement well-done access control permission and key management to prevent unauthorized personnel from carrying out physical contacts such as damaging hardware, unauthorized connection of removable device (such as USB flash disk, serial port), etc.

2. Change Passwords Regularly

We suggest that you change passwords regularly to reduce the risk of being guessed or cracked.

3. Set and Update Passwords Reset Information Timely

The device supports password reset function. Please set up related information for password reset in time, including the end user's mailbox and password protection questions. If the information changes, please modify it in time. When setting password protection questions, it is suggested not to use those that can be easily guessed.

4. Enable Account Lock

The account lock feature is enabled by default, and we recommend you to keep it on to guarantee the account security. If an attacker attempts to log in with the wrong password several times, the corresponding account and the source IP address will be locked.

5. Change Default HTTP and Other Service Ports

We suggest you to change default HTTP and other service ports into any set of numbers between 1024~65535, reducing the risk of outsiders being able to guess which ports you are using.

6. Enable HTTPS

We suggest you to enable HTTPS, so that you visit Web service through a secure communication channel.

7. MAC Address Binding

We recommend you to bind the IP and MAC address of the gateway to the device, thus reducing the risk of ARP spoofing.

8. Assign Accounts and Privileges Reasonably

According to business and management requirements, reasonably add users and assign a minimum set of permissions to them.

9. Disable Unnecessary Services and Choose Secure Modes

If not needed, we recommend turning off some services such as SNMP, SMTP, UPnP, etc., to reduce risks.

If necessary, it is highly recommended that you use safe modes, including but not limited to the following services:

- SNMP: Choose SNMP v3, and set up strong encryption passwords and authentication passwords.
- SMTP: Choose TLS to access mailbox server.
- FTP: Choose SFTP, and set up strong passwords.
- AP hotspot: Choose WPA2-PSK encryption mode, and set up strong passwords.

10. Audio and Video Encrypted Transmission

If your audio and video data contents are very important or sensitive, we recommend that you use encrypted transmission function, to reduce the risk of audio and video data being stolen during transmission.

Reminder: encrypted transmission will cause some loss in transmission efficiency.

11. Secure Auditing

- Check online users: we suggest that you check online users regularly to see if the device is logged in without authorization.
- Check device log: By viewing the logs, you can know the IP addresses that were used to log in to your devices and their key operations.

12. Network Log

Due to the limited storage capacity of the device, the stored log is limited. If you need to save the log for a long time, it is recommended that you enable the network log function to ensure that the critical logs are synchronized to the network log server for tracing.

13. Construct a Safe Network Environment

In order to better ensure the safety of device and reduce potential cyber risks, we recommend:

- Disable the port mapping function of the router to avoid direct access to the intranet devices from external network.
- The network should be partitioned and isolated according to the actual network needs. If there are no communication requirements between two sub networks, it is suggested to use VLAN, network GAP and other technologies to partition the network, so as to achieve the network isolation effect.
- Establish the 802.1x access authentication system to reduce the risk of unauthorized access to private networks.
- Enable IP/MAC address filtering function to limit the range of hosts allowed to access the device.